

ROLLERI

TOOLING LAB

LASER CONSUMABLES
PUNCHING TOOLS - IRON WORKER
SHEAR BLADES
PANEL BENDING TOOLS

BENDING

R1 TOOLS TYPE

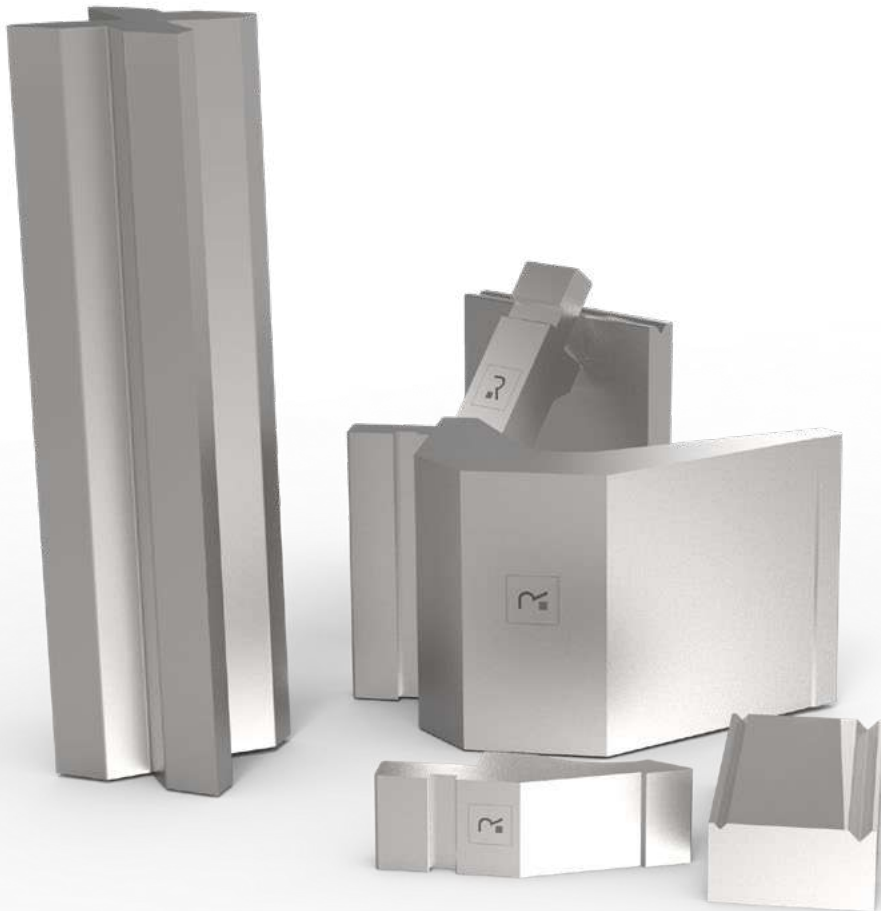



ISO 9001 - ISO 45001
CERTIFIED
COMPANY



Scan the QRCode or click on it and watch the video. You can follow our official Youtube channel www.youtube.com/Rollerispa or watch the video on our web site <https://www.rolleritools.com/media>



Download Rolleri **Bending App**

You will also get our sheet metal unfolding software for free and our bending rule. You can also scan the QR Code of this catalogue by using the app.

Request our clamping, punching and ironworker, consumables laser, panel bending tools and shear blades catalogues on www.rolleritools.com/download



The **Bending handbook** target is to supply practice and useful information to reach quickly the required result. A lot of examples, easy formulas and information which explain the proper attitude towards the bending process.



Create your account on www.rolleritools.com You can use Rolleri website to check the delivery time, request quotes, stay update with the news, check prices and place orders directly.



Click on the QR Code near the codes or scan it to check prices and delivery time.



Check the standard sectioning available. Customized sectioning is also available on request. sales@rolleri.it to know more about price and availability.



BENDING TOOLS

R1 TOOLS TYPE

Compatible with press brakes: Accurl, Accurpress, ACL, Adira, Amada, Atlantic, Baykal, BL, Boschert, Boutillon, Bystronic, Beyeler, Euro-B, Coastone, Colgar, Dener, Deratech, Durmazlar, Ermaksan, Farina, Gade, Gasparini, Gecko, Gilardi, Gizelis, Haco, Hindustan, HPM, Iturraspe, Jfy, JMT, LFK, Metfab, MVD, Oriance, Prima Power, Promecam, Rico, Salvagnini, Schiavi, SMD, Sorg, Somo, Vicla, Vimercati, Warcom, Yawei,...

R2-R3 TOOLS TYPE

Compatible with press brakes: Darley, LVD, Safan, Trumpf and press brakes with NSCL system, Bystronic Beyeler RFA, RF, R, S

R4 TOOLS TYPE

Compatible with press brakes: LVD

R5 TOOLS TYPE

Compatible with press brakes: American

R6 TOOLS TYPE

Compatible with press brakes: Hämmerle-Bystronic

R7 TOOLS TYPE

Compatible with press brakes: Colly

R8 TOOLS TYPE

Compatible with press brakes: Colgar

R9 TOOLS TYPE

Compatible with press brakes: Gasparini (axial)

R10 TOOLS TYPE

Compatible with press brakes: Ajial Axial

Rx TOOLS TYPE

Compatible with press brakes: EHT, Ursviken and Weinbrenner

ROLLERI TECH, MODIFICATIONS AND SERVICES

Compatible with all types of press brakes

CLAMPING SYSTEMS, INTERMEDIATES AND ADAPTERS

Compatible with all types of press brakes

ROLLA-V AND SPECIAL DIES

Compatible with all types of press brakes

MARK FREE BENDING AND ACCESSORIES

Compatible with all types of press brakes

PANEL BENDING TOOLS

SHEAR BLADES

PUNCHING TOOLS

R1 TOOLS TYPE

Compatible with punching machines Amada, Amada ABS, Wilson HP, Wilson HP WLS, Mate Ultra Tec

R2 TOOLS TYPE

Compatible with Trumpf punching machines

RS TOOLS TYPE

Compatible with Salvagnini punching machines

SPECIAL TOOLS

Compatible with different types of punching machines

ACCESSORIES

Compatible with different types of punching machines

IRON WORKER

Iron cutting tools

LASER CONSUMABLES

Find out more about our wide range of laser consumables: one of the most complete in the market

6 R1 PUNCHES

8 - PUNCHES: CONTENT EXPLANATION

10 - PUNCHES TOP SERIE

12 - HEMMING TOOLS TOP SERIE

14 - RADIUS TOOLS TOP SERIE

15 - PUNCHES CLASSIC SERIE

31 - MOVABLE HORNS

32 - JOGGLE TOOLS

33 - RADIUS TOOLS

35 - HEMMING TOOLS CLASSIC SERIE

36 - PUNCHES A SERIE

40 - PUNCHES CFH SERIE

42 R1 DIES

44 - DIES: CONTENT EXPLANATION

46 - 2-V DIES CLASSIC SERIE

48 - 2-V SELF CENTERING DIES CLASSIC SERIE

50 - 1-V SELF CENTERING DIES CLASSIC SERIE

53 - T DIES CLASSIC SERIE

71 - 1-V DIES CLASSIC SERIE

74 - MULTI-V DIES CLASSIC SERIE

76 - HEMMING DIES CLASSIC SERIE

78 - SPRING-LOADED HEMMING DIES CLASSIC SERIE

80 - PNEUMATIC HEMMING DIES CLASSIC SERIE

82 - HEAVY DUTY HEMMING DIES CLASSIC SERIE

84 - 2-V DIES A SERIE

86 - 2-V DIES A SERIE

90 - 1-V DIES A SERIE

96 - DIES CFH SERIE

R1

PUNCHES

Accurl, Accurpress, ACL, Adira, Amada, Atlantic, Baykal, BL, Boschert, Boutillon, Bystronic Beyeler, Euro-B, Coastone, Colgar, Dener, Deratech, Durmazlar, Ermaksan, Farina, Gade, Gasparini, Gecko, Gilardi, Gizelis, Haco, Hindustan, HPM, Iturrospe, Jfy, JMT, LFK, Metfab, MVD, Oriance, Prima Power, Promecam, Rico, Salvagnini, Schiavi, SMD, Sorg, Somo, Vicla, Vimercati, Warcom, Yawei,...

Our tool codes are listed according to the **tool angle**



STANDARD TANG

Punches are standardized with a 8.4 x 3.5 mm 0.33 x 1.37" safety groove, which keeps the tool from falling out.

Depending on the clamping system horizontal or vertical tool change is possible.

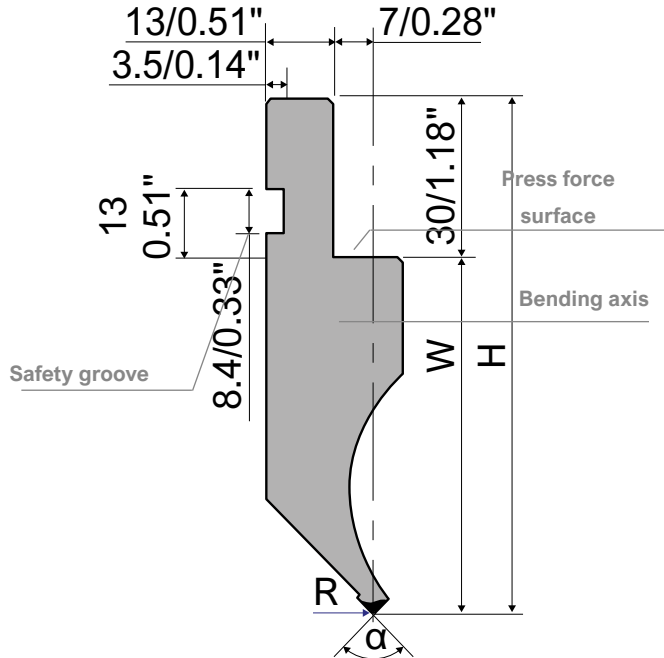

STANDARD LENGTH

	Serie TOP	Serie CLASSIC	Serie A	Serie CFH
500 mm 19.68"	○			
522 mm 20.55"	○			
525 mm 20.67"	●			
415 mm 16.34"		●	●	●
835 mm 32.87"		●	●	●
900 mm 35.43"		○		

○ available for some tool models only

SAFETY GROOVES MODIFICATION

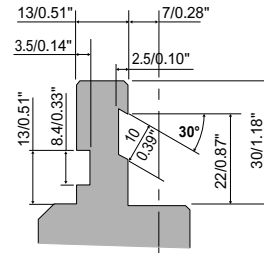

A1: Groove added for pneumatic system further to 8.4x3.5mm 0.33x1.37" groove

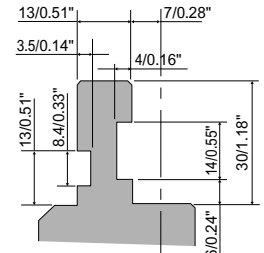

A6: Groove added for R3, Bystronic-Beyeler Euro and Safan tang further to 8.4x3.5mm 0.33x1.37" groove

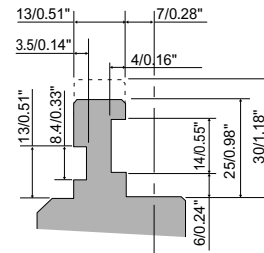

A7: Groove added and tang modified for R3 Bystronic-Beyeler Euro and Safan tang further to 8.4x3.5mm 0.33x1.37" groove

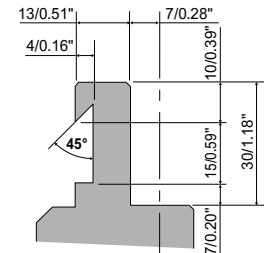

A8: Groove for Gasparini hydraulic clamping system

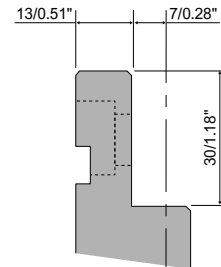

A9: Hole added for R2, R3 and RX tangs

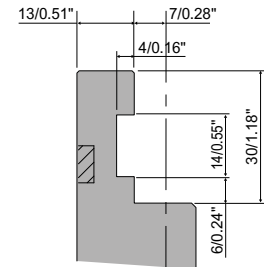

A41: Groove modified for R3, Bystronic-Beyeler Euro and Safan tang

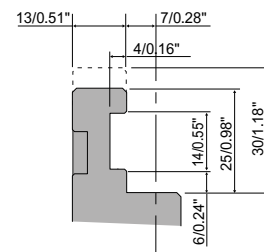

A42: Groove modified and tang modified for R3, Bystronic-Beyeler Euro and Safan tang

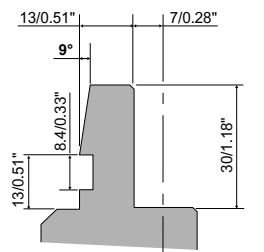

OT: Modification for Amada fast clamping system



Rolleri **BLACKFIRE** is a surface treatment against steel oxidation. This chemical treatment is a long-term solution against oxidation and rust.



Rolleri **FREEZINC** is a surface treatment to avoid metal residues of galvanized steel or aluminium from remaining on tools during bending. Tools are also protected from oxidation and you don't need to clean them anymore.



HORN TYPES

Check the standard horn in each code. All the other horns are available on request based on the series of the tool - check the feasibility with sales@rolleri.it

	TOP	CLASSIC	A	CFH
	1	•	•	•
	2	•		
	2/A	•		
	3	•	•	•
	4	•	•	•
	5	•	•	
	6	•	•	
	7	•	•	

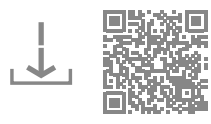

Request our clamping, punching and ironworker, consumables laser, panel bending tools and shear blades catalogues on www.rolleritools.com/download

SEGMENTATION

Customized sectioning is also available on request. sales@rolleri.it to know more about price and availability.

◀ = horn left ▶ = horn right

FA: 495 mm - 19.48"
 mm: 25-30-35-40-45-50-100-170
 in: 0.98-1.18-1.37-1.57-1.77-1.97-3.94-9.84

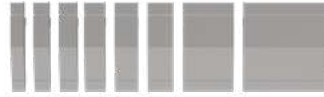

FB: 500 mm - 19.68"
 mm: <100-300-100>
 in: <3.94-11.81-3.94>



F: 805 mm - 31.69"
 mm: <100-370-10-15-20-40-50-100-100>
 in: <3.94-14.56-0.39-0.59-0.78-1.57-1.97-3.94-3.94>



FC: 800 mm - 31.50"
 mm: <100-10-15-20-40-50-165-300-100>
 in: <3.94-0.39-0.59-0.78-1.57-1.97-6.49-11.81-3.94>



FX: 795 mm - 31.29"
 mm: <100-250-20-25-30-35-40-45-50-100-100>
 in: <3.94-9.84-0.78-0.98-1.18-1.37-1.57-1.77-1.97-3.94-3.94>



FCA: 835 mm - 32.87"
 mm: 100-10-15-20-40-50-200-300-100
 in: 3.94-0.39-0.59-0.78-1.57-7.87-11.81-3.94

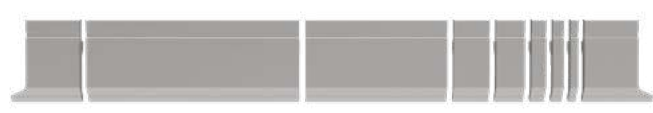

F: 800 mm - 31.49"
 mm: <100-300-150-50-40-20-15-15-10-100>
 in: <3.94-11.81-5.90-1.96-1.57-0.79-0.59-0.59-0.39-3.94>



Create your account on www.rolleritools.com
 You can use Rolleri website to check the delivery time, request quotes, stay update with the news, check prices and place orders directly.



TOP.175.85.R08

525 mm 20.67" 20.9 kg
 495 mm 19.49" 19.7 kg FA
 500 mm 19.68" 19.9 kg FB

85° >

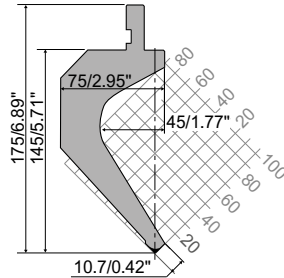

TOP.175.85.R2

525 mm 20.67" 20.9 kg
 495 mm 19.49" 19.7 kg FA
 500 mm 19.68" 19.9 kg FB

42Cr: 900-1150 N/mm²
 900 kN/m max.
 Horn 2

85°
 W=144.30 | H=174.30 | R=2 mm
 W=5.71 | H=6.89 | R=0.031 in



TOP.175.85.R08.S

525 mm 20.67" 18.5 kg
 495 mm 19.49" 17.4 kg FA
 500 mm 19.68" 17.6 kg FB

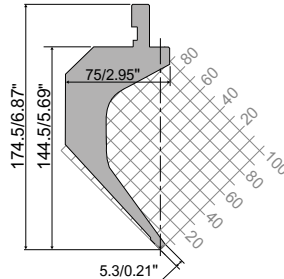

TOP.205.85.R08

525 mm 20.67" 24.0 kg
 495 mm 19.49" 22.6 kg FA
 500 mm 19.68" 22.9 kg FB

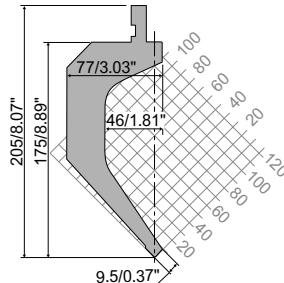

TOP.205.85.R2

525 mm 20.67" 24.0 kg
 495 mm 19.49" 22.6 kg FA
 500 mm 19.68" 22.9 kg FB

42Cr: 900-1150 N/mm²
 700 kN/m max.
 Horn 2

85°
 W=174.30 | H=204.30 | R=2 mm
 W=6.86 | H=8.04 | R=0.079 in



TOP.175.75.R08

525 mm 20.67" 21.5 kg
 495 mm 19.49" 20.3 kg FA
 500 mm 19.68" 20.5 kg FB

75° >

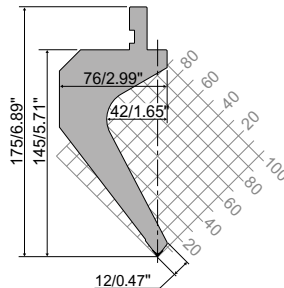

TOP.175.75.R2

525 mm 20.67" 21.5 kg
 495 mm 19.49" 20.3 kg FA
 500 mm 19.68" 20.5 kg FB

42Cr: 900-1150 N/mm²
 700 kN/m max.
 Horn 2

75°
 W=144.20 | H=174.30 | R=2 mm
 W=5.68 | H=6.86 | R=0.079 in



FA: 495 mm - 19.48"
 mm: 25-30-35-40-45-50-100-170
 in: 0.98-1.18-1.37-1.57-1.77-1.97-3.94-9.84



FB: 500 mm - 19.68"
 mm: <100-300-100>
 in: <3.94-11.81-3.94>

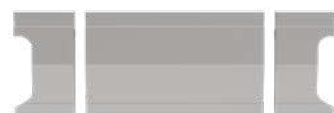



TOP.175.60.R08

525 mm 20.67" 12.0 kg
 495 mm 19.49" 11.3 kg FA
 500 mm 19.68" 11.4 kg FB

60° >

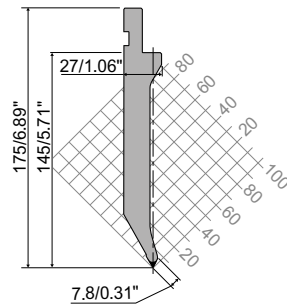

TOP.175.60.R2

525 mm 20.67" 20.9 kg
 495 mm 19.49" 19.7 kg FA
 500 mm 19.68" 19.9 kg FB

42Cr: 900-1150 N/mm²
 900 kN/m max.
 Horn 2

60°
 W=143.80 | H=173.80 | R=2 mm
 W=5.66 | H=6.84 | R=0.079 in



TOP.175.60.R5

525 mm 20.67" 21.5 kg
 495 mm 19.49" 21.0 kg FA
 500 mm 19.68" 19.0 kg FB

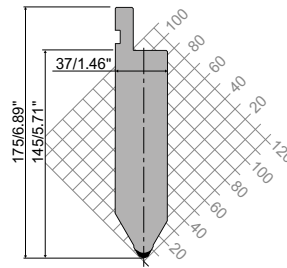

TOP.175.26.R08

525 mm 20.67" 11.0 kg
 495 mm 19.49" 10.4 kg FA
 500 mm 19.68" 10.5 kg FB

26° >

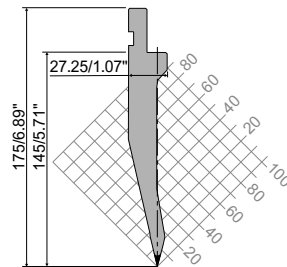

TOP.205.26.R08

525 mm 20.67" 15.6 kg
 495 mm 19.49" 16.7 kg FA
 500 mm 19.68" 16.8 kg FB

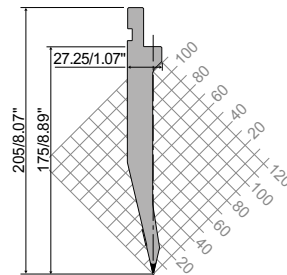

FA: 495 mm - 19.48"
 mm: 25-30-35-40-45-50-100-170
 in: 0.98-1.18-1.37-1.57-1.77-1.97-3.94-9.84



FB: 500 mm - 19.68"
 mm: <100-300-100>
 in: <3.94-11.81-3.94>



TOP.250.26.R1

525 mm	20.67"	17.7 kg	
495 mm	19.49"	17.7 kg	FA
500 mm	19.68"	17.7 kg	FB

42Cr: 900-1150 N/mm²
 1000 kN/m max.
 Horn 2

26°
 W=220 | H=250 | R=1 mm
 W=8.66 | H=9.84 | R=0.039 in

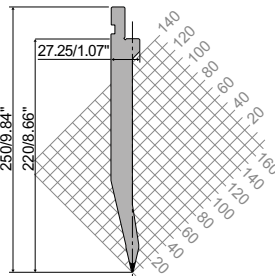

Hemming tools TOP serie

Hemming tools are used to prebend and afterwards flatten a sheet metal edge by using the same tool set.

Thanks to this operation you can strengthen sheet metal edges and avoid burr on their external side. For this reason, this operation is especially used for safety reason, in order to avoid operators' accidental injuries which may occur to those who have to handle sheet metal parts.

The maximum sheet metal thickness usually recommended for this operation is 3mm mild steel and 2mm stainless steel. However, for thicker sheet metal special solutions can be proposed, which consider the necessary bending force involved to flatten.

There are 2 types of flattening: partial flattening and total flattening. Partial flattening is a kind of flattening which doesn't win against the sheet metal springback. For this reason, if you measure the flattened point, it won't be twice the sheet metal thickness but a bigger measure; for example, if you flatten 1.5mm partially, the flattened point will be about 4mm. This dimension depends on the bending force only. Hence, if you want to flatten 1.5mm mild steel and get

3mm high flattened point, you have to increase the tonnage. In the table below you can check the necessary tonnage according to sheet metal thickness and type.

The choice of hemming tools should be influenced by the sheet metal type to be flattened; 35° punch and dies are recommended to flatten aluminium and mild steel, which have small springback, whereas more resistant sheet metal types like stainless steel require at least 30°, or better 26°, punch and die.

Springback control is fundamental to win against sheet metal resistance during the flattening phase. In fact, if the angle obtained during the pre-bending phase is too wide, sheet metal will slip towards the operator during the flattening phase.

The choice of TOP serie hemming tools with dies with U shape opening has to take into consideration the fact that the U opening of the die has to match perfectly with the punch tip width. These tools are 525mm long and the sectioned set is also available.

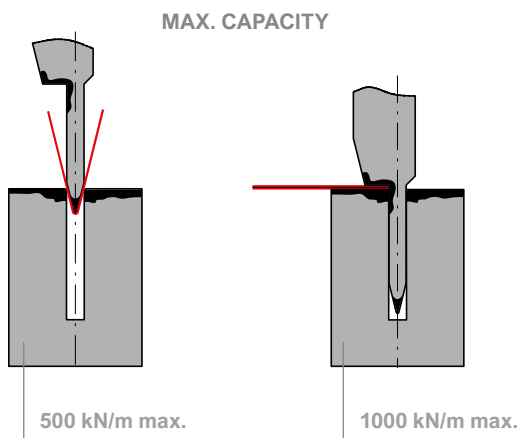

FA: 495 mm - 19.48"
 mm: 25-30-35-40-45-50-100-170
 in: 0.98-1.18-1.37-1.57-1.77-1.97-3.94-9.84



S	S	A	A	R.420 N/mm ²	R.700 N/mm ²
mm	in	mm	in	kN/m	kN/m
0.60	0.02	3.0	0.12	90	150
0.80	0.03	3.0	0.12	120	200
1.00	0.04	3.5	0.14	150	250
1.25	0.05	3.5	0.14	170	260



S	S	A	A	R.420 N/mm ²	R.700 N/mm ²
mm	in	mm	in	kN/m	kN/m
0.60	0.02	1.2	0.05	230	350
0.80	0.03	1.6	0.06	320	500
1.00	0.04	1.0	0.04	400	600
1.25	0.05	2.5	0.10	500	800

FB: 500 mm - 19.68"
 mm: <100-300-100>
 in: <3.94-11.81-3.94>





TOP150.30.R12

500 mm 19.68" 8.75 kg
 550 mm 21.65" 9.62 kg FA

30° >

C45: 560-710 N/mm²
 1000 kN/m max.

30°
 W=120 | H=150 | R=1.2 mm
 W=4.72 | H=5.90 | R=0.047 in

NOVINKA



To use with:
SM55.14.30/C
SM55.12.30/C

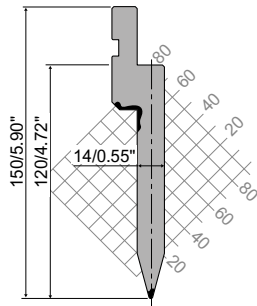

TOP.SP.134.28.8

525 mm 20.67" 12.0 kg
 495 mm 19.49" 11.3 kg FA

28° >

42Cr: 900-1150 N/mm²
 800 - 1000 kN/m max.

28°
 W=128 | H=158 | R=0.6 mm
 W=5.04 | H=6.22 | R=0.024 in



To use with:
TOP.SM-134.28.8
TOP.SM-134.24.8

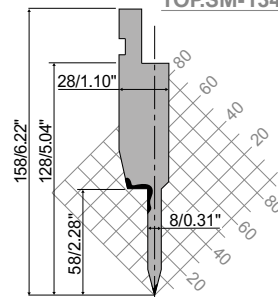

TOP.SP.134.24.8

525 mm 20.67" 11.0 kg
 495 mm 19.49" 10.3 kg FA

24° >

42Cr: 900-1150 N/mm²
 800 - 1000 kN/m max.

24°
 W=128 | H=158 | R=0.6 mm
 W=5.04 | H=6.22 | R=0.024 in



TOP.SP.134.24.10

525 mm 20.67" 11.0 kg
 495 mm 19.49" 10.3 kg FA



To use with:
TOP.SM-134.24.10

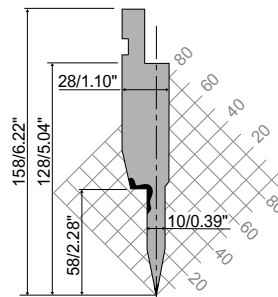

TOP.SP.134.24.12

525 mm 20.67" 11.6 kg
 495 mm 19.49" 11.0 kg FA



To use with:
TOP.SM-134.24.12

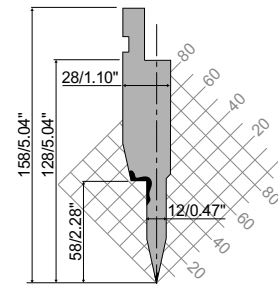

FA: 495 mm - 19.48"
 mm: 25-30-35-40-45-50-100-170
 in: 0.98-1.18-1.37-1.57-1.77-1.97-3.94-9.84



FW: 550 mm 21.65"
 mm: <100-100-50-45-40-35-30-25-25-100>
 in: <3.94-3.94-1.97-1.77-1.57-1.37-1.18-0.98-0.98-3.94>



TOP.PC.120-08

522 mm 20.55" 11.0 kg
495 mm 19.49" 10.5 kg FA

42Cr: 900-1150 N/mm²
1000 kN/m max.

W=90 | H=120 mm
W=3.54 | H=4.72 in

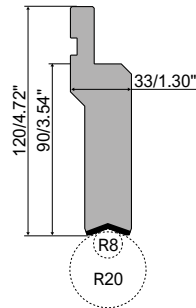

TOP.PC.120-20

522 mm 20.55" 10.5 kg
495 mm 19.49" 10 kg FA

42Cr: 900-1150 N/mm²
1000 kN/m max.

W=90 | H=120 mm
W=3.54 | H=4.72 in

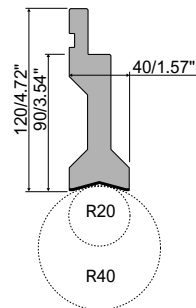

RADIUS TOOLS: R08-R40

	R mm	R in	525 mm 20.67 in	FA
TOP.C08	8.0	0.31	0.8 kg	0.8 kg
TOP.C09	9.0	0.35	1.0 kg	1.0 kg
TOP.C10	10.0	0.39	1.3 kg	1.2 kg
TOP.C11	11.0	0.43	1.6 kg	1.5 kg
TOP.C12.5	12.5	0.49	2.0 kg	1.9 kg
TOP.C14	14.0	0.55	2.5 kg	2.4 kg
TOP.C15	15.0	0.59	2.9 kg	2.7 kg
TOP.C16	16.0	0.63	3.3 kg	3.1 kg
TOP.C17.5	17.5	0.69	4.0 kg	3.7 kg
TOP.C19	19.0	0.75	4.7 kg	4.4 kg
TOP.C20	20.0	0.79	5.2 kg	4.9 kg
TOP.C21	21.0	0.83	5.7 kg	5.4 kg
TOP.C22.5	22.5	0.88	6.6 kg	6.2 kg
TOP.C24	24.0	0.94	7.5 kg	7.0 kg
TOP.C25	25.0	0.98	8.1 kg	7.6 kg
TOP.C27.5	27.5	1.08	9.8 kg	9.2 kg
TOP.C30	30.0	1.18	11.6 kg	11.0 kg
TOP.C32.5	32.5	1.28	13.7 kg	12.9 kg
TOP.C35	35.0	1.14	15.9 kg	14.9 kg
TOP.C37.5	37.5	1.47	18.2 kg	17.2 kg
TOP.C40	40.0	1.57	20.7 kg	19.5 kg

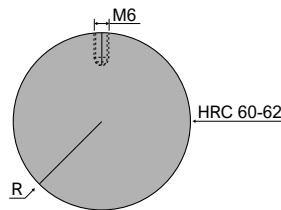

C53: 610 -760 N/mm²
1000 kN/m max.

FA: 495 mm - 19.48"
mm: 25-30-35-40-45-50-100-170
in: 0.98-1.18-1.37-1.57-1.77-1.97-3.94-9.84



The Bending handbook target is to supply practice and useful information to reach quickly the required result. A lot of examples, easy formulas and information which explain the proper attitude towards the bending process.



PK.97.90.R06

835 mm	32.87"	10.5 kg	
415 mm	16.34"	5.2 kg	
795 mm	31.29"	10.1 kg	FX
805 mm	31.69"	10.1 kg	F

90° >

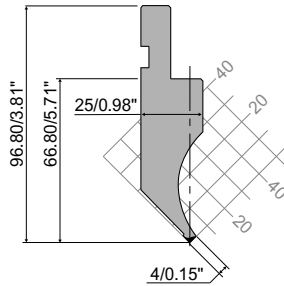

P.97.90.R025

835 mm	32.87"	10.5 kg	
415 mm	16.34"	5.2 kg	
795 mm	31.29"	10.1 kg	FX
805 mm	31.69"	10.1 kg	F

42Cr: 900-1150 N/mm²
350 kN/m max.
Horn 1

90°
W=66.80 | H=96.80 | R=0.25 mm
W=5.71 | H=3.81 | R=0.010 in



PK.97.90.R08

835 mm	32.87"	11 kg	
415 mm	16.34"	5.5 kg	
795 mm	31.29"	10.5 kg	FX
805 mm	31.69"	10.5 kg	F

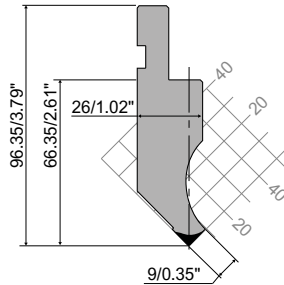

PK.97.90.R025

835 mm	32.87"	11 kg	
415 mm	16.34"	5.5 kg	
795 mm	31.29"	10.5 kg	FX
805 mm	31.69"	10.5 kg	F

C45: 560-710 N/mm²
1000 kN/m max.
Horn 1

90°
W=66.35 | H=96.35 | R=0.25 mm
W=2.61 | H=3.79 | R=0.010 in



PK.114.90.R06

835 mm	32.87"	15.6 kg	
415 mm	16.34"	7.7 kg	
795 mm	31.29"	14.8 kg	FX
805 mm	31.69"	15.0 kg	F

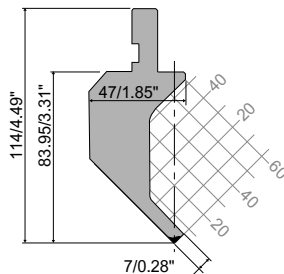

42Cr: 900-1150 N/mm²
950 kN/m max.
Horn 2

90°
W=83.95 | H=114 | R=0.6 mm
W=3.31 | H=4.49 | R=0.02 in

PK.116.90.R08

835 mm	32.87"	13 kg	
415 mm	16.34"	6.5 kg	
795 mm	31.29"	12.3 kg	FX
805 mm	31.69"	12.5 kg	F

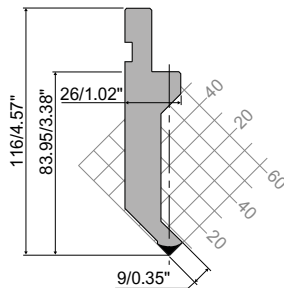

C45: 560-710 N/mm²
400 kN/m max.
Horn 1

90°
W=83.95 | H=116 | R=0.8 mm
W=3.38 | H=4.57 | R=0.031 in

FX: 795 mm - 31.29"

mm: <100-250-20-25-30-35-40-45-50-100-100>
in: <3.94-9.84-0.78-0.98-1.18-1.37-1.57-1.77-1.97-3.94-3.94>

F: 805 mm - 31.69"

mm: <100-370-10-15-20-40-50-100-100>
in: <3.94-14.56-0.39-0.59-0.78-1.57-1.97-3.94-3.94>



DK.116.90.R08

835 mm	32.87"	11.9 kg	
415 mm	16.34"	5.8 kg	
795 mm	31.29"	11.3 kg	FX
805 mm	31.69"	11.5 kg	F

C45: 560-710 N/mm²
500 kN/m max.
Horn 1

90°
W=86 | H=116 | R=0.8 mm
W=3.39 | H=4.57 | R=0.031 in

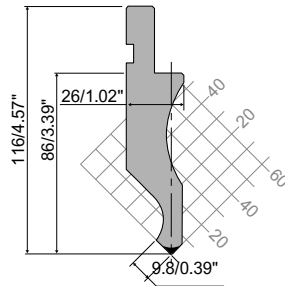

PK.120.90.R08

835 mm	32.87"	21.0 kg	
415 mm	16.34"	10.5 kg	
795 mm	31.29"	20.0 kg	FX
805 mm	31.69"	20.2 kg	F

C45: 560-710 N/mm²
600 kN/m max.
Horn 1

90°
W=89.35 | H=119.35 | R=0.8 mm
W=3.52 | H=4.70 | R=0.031 in

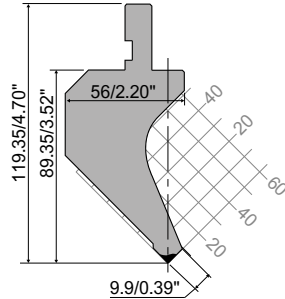

PK.120.90.R025

835 mm	32.87"	21.0 kg	
415 mm	16.34"	10.5 kg	
795 mm	31.29"	20.0 kg	FX
805 mm	31.69"	20.2 kg	F

C45: 560-710 N/mm²
600 kN/m max.
Horn 1

90°
W=89.6 | H=119.6 | R=0.25 mm
W=3.53 | H=4.71 | R=0.010 in



P.130.90.R06

835 mm	32.87"	9.8 kg	
415 mm	16.34"	4.9 kg	
795 mm	31.29"	9.3 kg	FX
805 mm	31.69"	9.4 kg	F

42Cr: 900-1150 N/mm²
350 kN/m max.
Horn 1

90°
W=100 | H=130 | R=0.6 mm
W=3.94 | H=5.12 | R=0.024 in

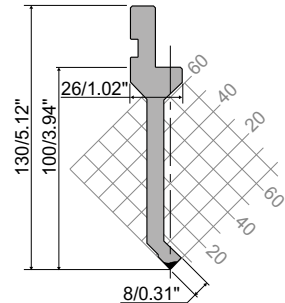

P.130.90.R025

835 mm	32.87"	9.8 kg	
415 mm	16.34"	4.9 kg	
795 mm	31.29"	9.3 kg	FX
805 mm	31.69"	9.4 kg	F

42Cr: 900-1150 N/mm²
350 kN/m max.
Horn 1

90°
W=100 | H=130 | R=0.25 mm
W=3.94 | H=5.12 | R=0.010 in



PK.135.90.R08

835 mm	32.87"	22.7 kg	
415 mm	16.34"	11.3 kg	
795 mm	31.29"	21.7 kg	FX
805 mm	31.69"	22.0 kg	F

C45: 560-710 N/mm²
500 kN/m max.
Horn 1

90°
W=104.35 | H=134.35 | R=0.8 mm
W=4.11 | H=5.29 | R=0.031 in

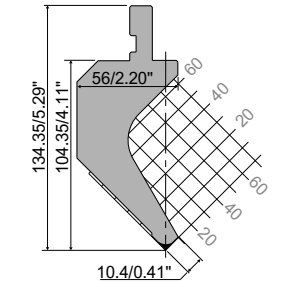

PK.135.90.R025

835 mm	32.87"	22.7 kg	
415 mm	16.34"	11.3 kg	
795 mm	31.29"	21.7 kg	FX
805 mm	31.69"	22.0 kg	F

C45: 560-710 N/mm²
500 kN/m max.
Horn 1

90°
W=104.6 | H=134.6 | R=0.25 mm
W=4.12 | H=5.30 | R=0.010 in



FX: 795 mm - 31.29"

mm: <100-250-20-25-30-35-40-45-50-100-100>

in: <3.94-9.84-0.78-0.98-1.18-1.37-1.57-1.77-1.97-3.94-3.94>

F: 805 mm - 31.69"

mm: 100-370-10-15-20-40-50-100-100

in: 3.94-14.56-0.39-0.59-0.78-1.57-1.97-3.94-3.94

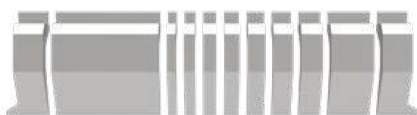



P.95.88.R3

835 mm	32.87"	11 kg	
415 mm	16.34"	5.5 kg	
795 mm	31.29"	10.5 kg	FX
805 mm	31.69"	10.6 kg	F

88° >

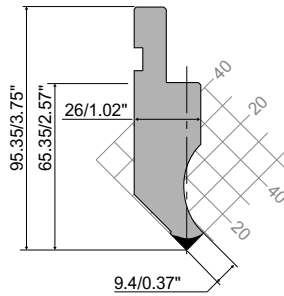

C45: 560-710 N/mm²
1000 kN/m max.
Horn 1

88°
W=65.35 | H=95.35 | R=3 mm
W=2.57 | H=3.75 | R=0.12 in

P.97.88.R06

835 mm	32.87"	9.5 kg	
415 mm	16.34"	5.0 kg	
795 mm	31.29"	9.2 kg	FX
805 mm	31.69"	9.5 kg	F
900 mm	35.43"	11.0 kg	

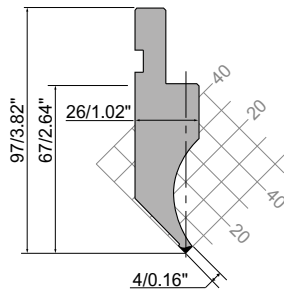

C45: 560-710 N/mm²
350 kN/m max.
Horn 1

88°
W=67.00 | H=97.00 | R=0.6 mm
W=2.64 | H=3.82 | R=0.024 in

P.97.88.R025

835 mm	32.87"	9.5 kg	
415 mm	16.34"	5 kg	
795 mm	31.29"	9.2 kg	FX
805 mm	31.69"	9.5 kg	F
900 mm	35.43"	11.0 kg	

C45: 560-710 N/mm²
350 kN/m max.
Horn 1

88°
W=66.95 | H=96.95 | R=0.25 mm
W=2.64 | H=3.82 | R=0.010 in

P.97.88.R08

835 mm	32.87"	11.1 kg	
415 mm	16.34"	5.5 kg	
795 mm	31.29"	10.6 kg	FX
805 mm	31.69"	10.7 kg	F
900 mm	35.43"	11.9 kg	

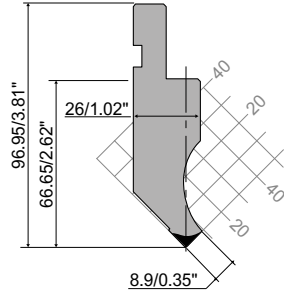

C45: 560-710 N/mm²
1000 kN/m max.
Horn 1

88°
W=66.65 | H=96.65 | R=0.8 mm
W=2.62 | H=3.81 | R=0.031 in

PK.97.88.R025

835 mm	32.87"	11.1 kg	
415 mm	16.34"	5.5 kg	
795 mm	31.29"	10.6 kg	FX
805 mm	31.69"	10.7 kg	F
900 mm	35.43"	11.9 kg	

C45: 560-710 N/mm²
1000 kN/m max.
Horn 1

88°
W=66.60 | H=96.60 | R=0.25 mm
W=2.62 | H=3.80 | R=0.010 in

P.114.88.R06

835 mm	32.87"	15.6 kg	
415 mm	16.34"	7.7 kg	
795 mm	31.29"	14.8 kg	FX
805 mm	31.69"	15.0 kg	F

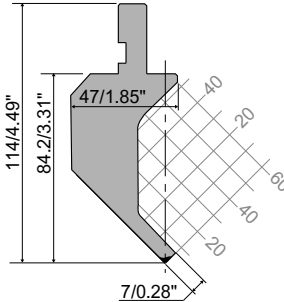

42Cr: 900-1150 N/mm²
200 kN/m max.
Horn 1

88°
W=84.20 | H=114 | R=0.6 mm
W=3.31 | H=4.49 | R=0.024 in

FX: 795 mm - 31.29"

mm: <100-250-20-25-30-35-40-45-50-100-100>

in: <3.94-9.84-0.78-0.98-1.18-1.37-1.57-1.77-1.97-3.94-3.94>

F: 805 mm - 31.69"

mm: <100-370-10-15-20-40-50-100-100>

in: <3.94-14.56-0.39-0.59-0.78-1.57-1.97-3.94-3.94>

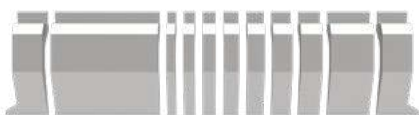

P.115.88.R06

835 mm	32.87"	13.0 kg
415 mm	16.34"	6.5 kg
795 mm	31.29"	12.4 kg FX
805 mm	31.69"	12.6 kg F

42Cr: 900-1150 N/mm²
130 kN/m max.
Horn 1

88°
W=85 | H=115 | R=0.6 mm
W=3.35 | H=4.53 | R=0.024 in

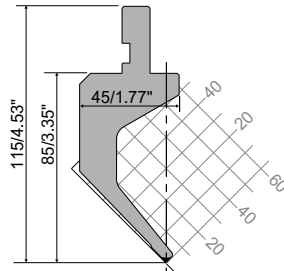

D.116.88.R08

835 mm	32.87"	11.9 kg
415 mm	16.34"	5.8 kg
795 mm	31.29"	11.3 kg FX
805 mm	31.69"	11.5 kg F

C45: 560-710 N/mm²
500 kN/m max.
Horn 1

88°
W=86.00 | H=116.00 | R=0.8 mm
W=3.39 | H=4.57 | R=0.031 in

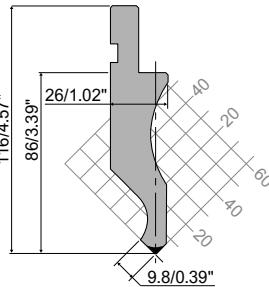

D.116.88.R3

835 mm	32.87"	11.9 kg
415 mm	16.34"	5.8 kg
795 mm	31.29"	11.3 kg FX
805 mm	31.69"	11.5 kg F

C45: 560-710 N/mm²
500 kN/m max.
Horn 1

88°
W=85.00 | H=115.00 | R=3 mm
W=3.35 | H=4.53 | R=0.118 in

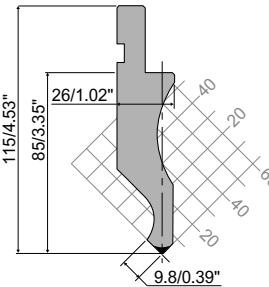

P.116.88.R08

835 mm	32.87"	12.0 kg
415 mm	16.34"	6.0 kg
795 mm	31.29"	11.4 kg FX
805 mm	31.69"	11.5 kg F

C45: 560-710 N/mm²
400 kN/m max.
Horn 1

88°
W=86 | H=116 | R=0.8 mm
W=3.39 | H=4.57 | R=0.031 in

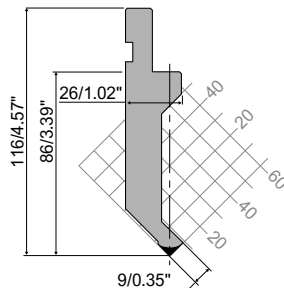

PS.120.88.R08

835 mm	32.87"	16.4 kg
415 mm	16.34"	8.2 kg
795 mm	31.29"	15.6 kg FX
805 mm	31.69"	15.8 kg F

C45: 560-710 N/mm²
450 kN/m max.
Horn 1

88°
W=89.70 | H=119.70 | R=0.8 mm
W=3.53 | H=4.71 | R=0.031 in

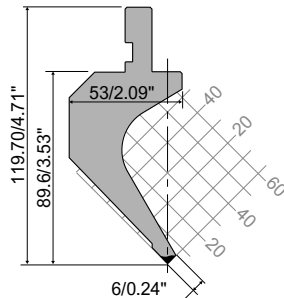

FX: 795 mm - 31.29"

mm: <100-250-20-25-30-35-40-45-50-100-100>
in: <3.94-9.84-0.78-0.98-1.18-1.37-1.57-1.77-1.97-3.94-3.94>

F: 805 mm - 31.69"

mm: <100-370-10-15-20-40-50-100-100>
in: <3.94-14.56-0.39-0.59-0.78-1.57-1.97-3.94-3.94>



P.125.88.R025

835 mm 32.87" 9.1 kg
 415 mm 16.34" 4.5 kg
 795 mm 31.29" 8.7 kg FX
 805 mm 31.69" 8.8 kg F

42Cr: 900-1150 N/mm²
 500 kN/m max.
 Horn 1

88°
 W=95.35 | H=125 | R=0.25 mm
 W=3.74 | H=4.92 | R=0.010 in

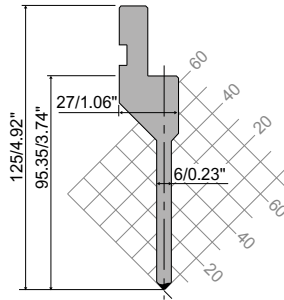

P.120.88.R08

835 mm 32.87" 21.4 kg
 415 mm 16.34" 10.7 kg
 795 mm 31.29" 20.5 kg FX
 805 mm 31.69" 20.7 kg F

C45: 560-710 N/mm²
 600 kN/m max.
 Horn 1

88°
 W=89.65 | H=120.00 | R=0.8 mm
 W=3.53 | H=4.72 | R=0.031 in

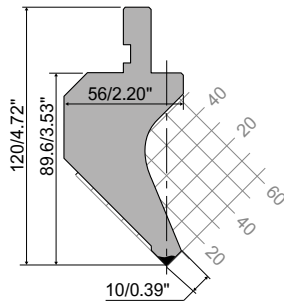

PK.120.88.R025

835 mm 32.87" 21.4 kg
 415 mm 16.34" 10.7 kg
 795 mm 31.29" 20.5 kg FX
 805 mm 31.69" 20.7 kg F

C45: 560-710 N/mm²
 600 kN/m max.
 Horn 1

88°
 W=89.6 | H=120.0 | R=0.25 mm
 W=3.53 | H=4.72 | R=0.010 in



P.120.88.R3

835 mm 32.87" 21.4 kg
 415 mm 16.34" 10.7 kg
 795 mm 31.29" 20.5 kg FX
 805 mm 31.69" 20.7 kg F

C45: 560-710 N/mm²
 600 kN/m max.
 Horn 1

88°
 W=88.50 | H=118.50 | R=3 mm
 W=3.48 | H=4.67 | R=0.118 in

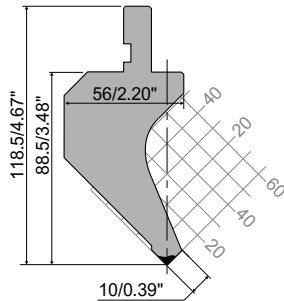

P.130.88.R06

835 mm 32.87" 9.8 kg
 415 mm 16.34" 4.9 kg
 795 mm 31.29" 9.3 kg FX
 805 mm 31.69" 9.4 kg F
 900 mm 35.43" 10.6 kg

42Cr: 900-1150 N/mm²
 350 kN/m max.
 Horn 1

88°
 W=100 | H=130 | R=0.6 mm
 W=3.94 | H=5.12 | R=0.024 in

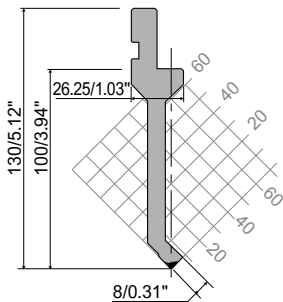

PK.130.88.R025

835 mm 32.87" 9.8 kg
 415 mm 16.34" 4.9 kg
 795 mm 31.29" 9.3 kg FX
 805 mm 31.69" 9.4 kg F
 900 mm 35.43" 10.6 kg

42Cr: 900-1150 N/mm²
 350 kN/m max.
 Horn 1

88°
 W=99.95 | H=129.95 | R=0.25 mm
 W=3.94 | H=5.12 | R=0.010 in

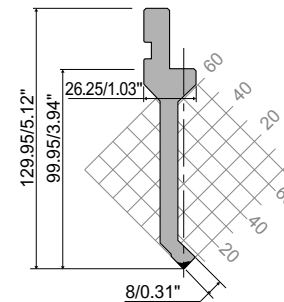

FX: 795 mm - 31.29"

mm: <100-250-20-25-30-35-40-45-50-100-100>

in: <3.94-9.84-0.78-0.98-1.18-1.37-1.57-1.77-1.97-3.94-3.94>

F: 805 mm - 31.69"

mm: <100-370-10-15-20-40-50-100-100>

in: <3.94-14.56-0.39-0.59-0.78-1.57-1.97-3.94-3.94>

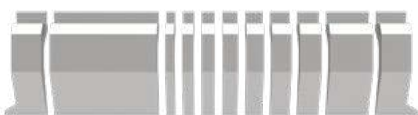

P.130.88.R08

835 mm	32.87"	13.7 kg	
415 mm	16.34"	6.8 kg	
795 mm	31.29"	13.0 kg	FX
805 mm	31.69"	13.2 kg	F

C45: 560-710 N/mm²
400 kN/m max.
Horn 1

88°
W=100.0 | H=130.0 | R=0.8 mm
W=3.94 | H=5.12 | R=0.031 in

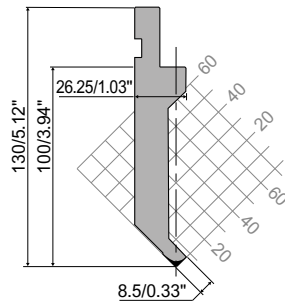

P.130.88.R025

835 mm	32.87"	13.7 kg	
415 mm	16.34"	6.8 kg	
795 mm	31.29"	13.0 kg	FX
805 mm	31.69"	13.2 kg	F

C45: 560-710 N/mm²
400 kN/m max.
Horn 1

88°
W=100.0 | H=130.0 | R=0.25 mm
W=3.94 | H=5.12 | R=0.010 in



P.135.88.R08

835 mm	32.87"	22.7 kg	
415 mm	16.34"	11.3 kg	
795 mm	31.29"	21.7 kg	FX
805 mm	31.69"	22.0 kg	F

C45: 560-710 N/mm²
500 kN/m max.
Horn 1

88°
W=104.6 | H=134.5 | R=0.8 mm
W=4.12 | H=5.30 | R=0.031 in

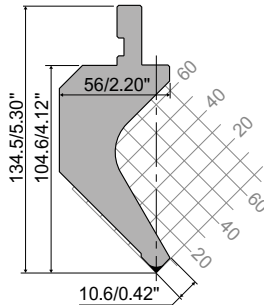

PK.135.88.R025

835 mm	32.87"	22.7 kg	
415 mm	16.34"	11.3 kg	
795 mm	31.29"	21.7 kg	FX
805 mm	31.69"	22.0 kg	F

C45: 560-710 N/mm²
500 kN/m max.
Horn 1

88°
W=104.6 | H=134.5 | R=0.25 mm
W=4.12 | H=5.30 | R=0.010 in



P.135.88.R3

835 mm	32.87"	22.7 kg	
415 mm	16.34"	11.3 kg	
795 mm	31.29"	21.7 kg	FX
805 mm	31.69"	22.0 kg	F

C45: 560-710 N/mm²
500 kN/m max.
Horn 1

88°
W=103.4 | H=133.4 | R=3.0 mm
W=4.07 | H=5.25 | R=0.118 in

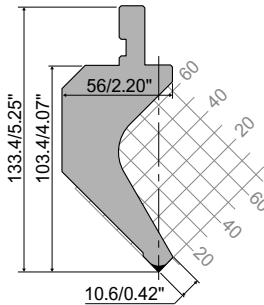

PS.135.88.R08

835 mm	32.87"	22.2 kg	
415 mm	16.34"	11.0 kg	
795 mm	31.29"	21.1 kg	FX
805 mm	31.69"	21.4 kg	F

C45: 560-710 N/mm²
450 kN/m max.
Horn 1

88°
W=104.6 | H=134.5 | R=0.8 mm
W=4.12 | H=5.30 | R=0.031 in

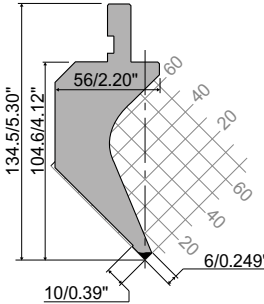

FX: 795 mm - 31.29"

mm: <100-250-20-25-30-35-40-45-50-100-100>
in: <3.94-9.84-0.78-0.98-1.18-1.37-1.57-1.77-1.97-3.94-3.94>

F: 805 mm - 31.69"

mm: <100-370-10-15-20-40-50-100-100>
in: <3.94-14.56-0.39-0.59-0.78-1.57-1.97-3.94-3.94>





PR.135.88.R08

835 mm	32.87"	23.8 kg
415 mm	16.34"	11.8 kg
795 mm	31.29"	22.7 kg FX
805 mm	31.69"	23.0 kg F

C45: 560-710 N/mm²
450 kN/m max.
Horn 1

88°
W=104.65 | H=134.5 | R=0.8 mm
W=4.12 | H=5.30 | R=0.031 in

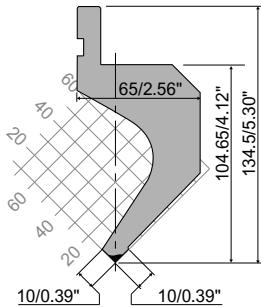

P.150.88.R08

835 mm	32.87"	21.2 kg
415 mm	16.34"	10.6 kg
795 mm	31.29"	20.2 kg FX
805 mm	31.69"	20.5 kg F
900 mm	35.43"	22.9 kg

42Cr: 900-1150 N/mm²
500 kN/m max.
Horn 1

88°
W=120.0 | H=150.0 | R=0.8 mm
W=4.72 | H=5.91 | R=0.031 in

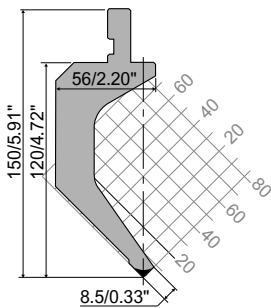

P.150.88.R3

835 mm	32.87"	21.2 kg
415 mm	16.34"	10.6 kg
795 mm	31.29"	20.2 kg FX
805 mm	31.69"	20.5 kg F
900 mm	35.43"	22.9 kg

42Cr: 900-1150 N/mm²
500 kN/m max.
Horn 1

88°
W=119.0 | H=149.0 | R=3.0 mm
W=4.69 | H=5.87 | R=0.118 in

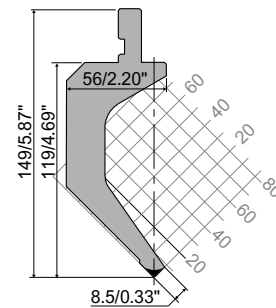

P.150.88.R06

835 mm	32.87"	10.9 kg
415 mm	16.34"	5.4 kg
795 mm	31.29"	10.3 kg FX
805 mm	31.69"	10.4 kg F
900 mm	35.43"	11.7 kg

42Cr: 900-1150 N/mm²
350 kN/m max.
Horn 1

88°
W=120.0 | H=150.0 | R=0.6 mm
W=4.72 | H=5.91 | R=0.024 in

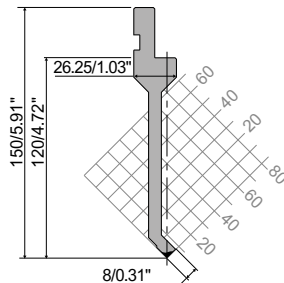

P.150.88.R025

835 mm	32.87"	10.2 kg
415 mm	16.34"	5.0 kg
795 mm	31.29"	9.7 kg FX
805 mm	31.69"	9.8 kg F

42Cr: 900-1150 N/mm²
500 kN/m max.
Horn 1

88°
W=120 | H=150 | R=0.25 mm
W=4.72 | H=5.91 | R=0.010 in

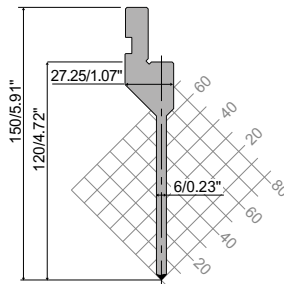

FX: 795 mm - 31.29"

mm: <100-250-20-25-30-35-40-45-50-100-100>
in: <3.94-9.84-0.78-0.98-1.18-1.37-1.57-1.77-1.97-3.94-3.94>



F: 805 mm - 31.69"

mm: <100-370-10-15-20-40-50-100-100>
in: <3.94-14.56-0.39-0.59-0.78-1.57-1.97-3.94-3.94>



P.175.88.R08

835 mm	32.87"	35.7 kg
415 mm	16.34"	17.7 kg
795 mm	31.29"	34.0 kg FX
805 mm	31.69"	34.4 kg F

C45: 560-710 N/mm²
400 kN/m max.
Horn 1

88°
W=145.0 | H=175.0 | R=0.8 mm
W=5.71 | H=6.89 | R=0.031 in

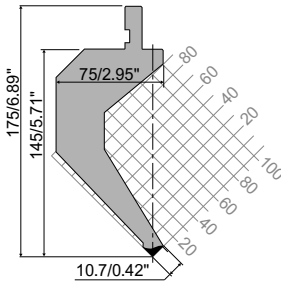

P.195.88.R08

835 mm	32.87"	40.8 kg
415 mm	16.34"	20.3 kg
795 mm	31.29"	38.8 kg FX
805 mm	31.69"	39.3 kg F

C45: 560-710 N/mm²
600 kN/m max.
Horn 1

88°
W=165 | H=195 | R=0.8 mm
W=6.50 | H=7.68 | R=0.031 in

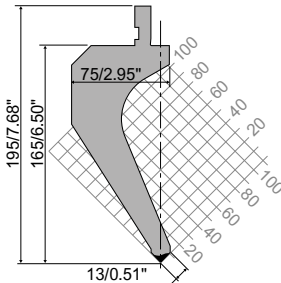

P.196.88.R06

835 mm	32.87"	42.0 kg
415 mm	16.34"	20.8 kg
795 mm	31.29"	40.0 kg FX
805 mm	31.69"	40.4 kg F
905 mm	35.43"	45.2 kg

C45: 560-710 N/mm²
400 kN/m max.
Horn 1

88°
W=166.6 | H=196.6 | R=0.6 mm
W=6.56 | H=7.74 | R=0.024 in

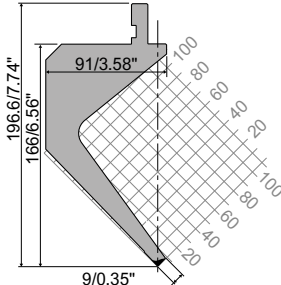

P.97.85.R08

835 mm	32.87"	11.0 kg
415 mm	16.34"	5.5 kg
795 mm	31.29"	10.4 kg FX
805 mm	31.69"	10.6 kg F

C45: 560-710 N/mm²
1000 kN/m max.
Horn 1

85°
W=66.60 | H=96.50 | R=0.8 mm
W=2.62 | H=3.80 | R=0.031 in

85° >

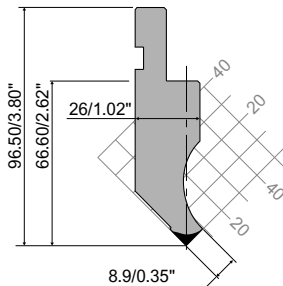

PK.95.85.R3

835 mm	32.87"	11 kg
415 mm	16.34"	5.5 kg
795 mm	31.29"	10.4 kg FX
805 mm	31.69"	10.6 kg F

C45: 560-710 N/mm²
1000 kN/m max.
Horn 1

85°
W=65.45 | H=95.45 | R=3 mm
W=2.58 | H=3.76 | R=0.118 in

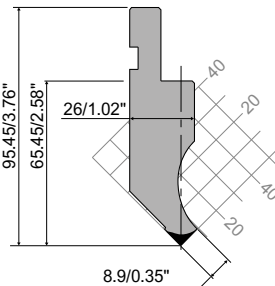

FX: 795 mm - 31.29"

mm: <100-250-20-25-30-35-40-45-50-100-100>
in: <3.94-9.84-0.78-0.98-1.18-1.37-1.57-1.77-1.97-3.94-3.94>

F: 805 mm - 31.69"

mm: <100-370-10-15-20-40-50-100-100>
in: <3.94-14.56-0.39-0.59-0.78-1.57-1.97-3.94-3.94>

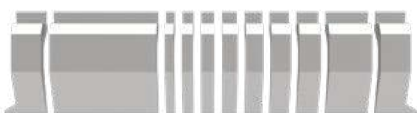

PK.120.85.R08

835 mm 32.87" 15.6 kg
 415 mm 16.34" 7.7 kg
 795 mm 31.29" 14.8 kg FX
 805 mm 31.69" 15.0 kg F

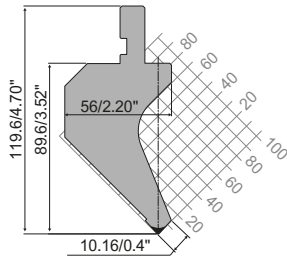

C45: 560-710 N/mm²
 600 kN/m max.
 Horn 1

85°
 W=89.6 | H=119.6 | R=0.8 mm
 W=3.52 | H=4.70 | R=0.031 in

P.120.85.R1

835 mm 32.87" 13.5 kg
 415 mm 16.34" 6.7 kg
 795 mm 31.29" 12.9 kg FX
 805 mm 31.69" 19 kg F

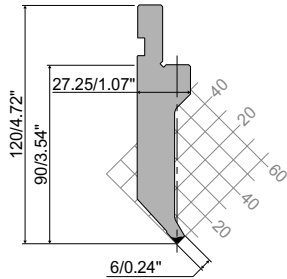

42Cr: 900-1150 N/mm²
 800 kN/m max.
 Horn 1

85°
 W=90.0 | H=120.0 | R=1 mm
 W=3.54 | H=4.72 | R=0.039 in

P.130.85.R025

835 mm 32.87" 9.8 kg
 415 mm 16.34" 4.9 kg
 795 mm 31.29" 9.3 kg FX
 805 mm 31.69" 9.4 kg F

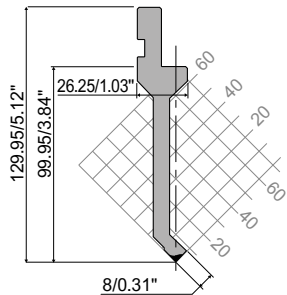

42Cr: 900-1150 N/mm²
 350 kN/m max.
 Horn 1

85°
 W=99.95 | H=129.95 | R=0.25 mm
 W=3.84 | H=5.12 | R=0.010 in

P.130.85.R08

835 mm 32.87" 13.7 kg
 415 mm 16.34" 6.8 kg
 795 mm 31.29" 13 kg FX
 805 mm 31.69" 13.2 kg F

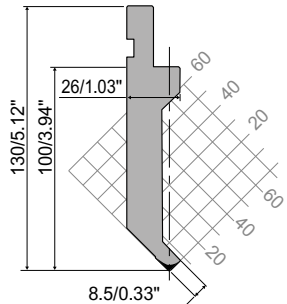

C45: 560-710 N/mm²
 400 kN/m max.
 Horn 1

85°
 W=100 | H=130 | R=0.8 mm
 W=3.94 | H=5.12 | R=0.031 in

FX: 795 mm - 31.29"

mm: <100-250-20-25-30-35-40-45-50-100-100>
 in: <3.94-9.84-0.78-0.98-1.18-1.37-1.57-1.77-1.97-3.94-3.94>

F: 805 mm - 31.69"

mm: <100-370-10-15-20-40-50-100-100>
 in: <3.94-14.56-0.39-0.59-0.78-1.57-1.97-3.94-3.94>

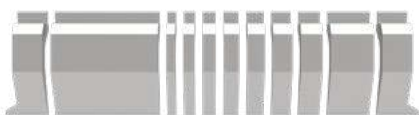

PK.135.85.R08

835 mm	32.87"	22.2 kg	
415 mm	16.34"	11.0 kg	
795 mm	31.29"	21.7 kg	FX
805 mm	31.69"	21.7 kg	F

C45: 560-710 N/mm²
500 kN/m max.
Horn 1

85°
W=104.6 | H=134.6 | R=0.8 mm
W=4.12 | H=5.30 | R=0.031 in

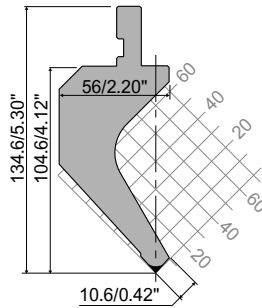

P.135.85.R08

835 mm	32.87"	20.9 kg	
415 mm	16.34"	10.4 kg	
795 mm	31.29"	19.2 kg	FX
805 mm	31.69"	20.2 kg	F

42Cr: 900-1150 N/mm²
800 kN/m max.
Horn 1

85°
W=105 | H=135 | R=0.8 mm
W=5.31 | H=4.13 | R=0.031 in

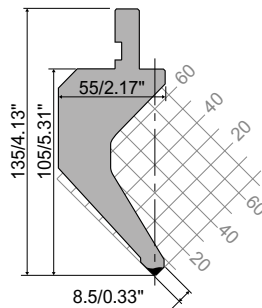

PS.135.85.R08

835 mm	32.87"	17.7 kg	
415 mm	16.34"	8.8 kg	
795 mm	31.29"	16.9 kg	FX
805 mm	31.69"	17.1 kg	F

C45: 560-710 N/mm²
1000 kN/m max.
Horn 1

85°
W=105 | H=135 | R=0.8 mm
W=4.13 | H=5.31 | R=0.031 in

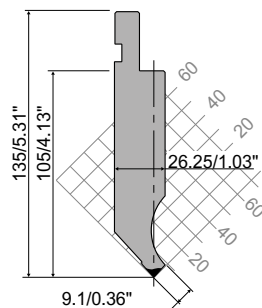

P.145.85.R08

835 mm	32.87"	22.6 kg	
415 mm	16.34"	11.2 kg	
795 mm	31.29"	21.5 kg	FX
805 mm	31.69"	21.8 kg	F

42Cr: 900-1150 N/mm²
600 kN/m max.
Horn 1

85°
W=115 | H=145 | R=0.8 mm
W=4.53 | H=5.71 | R=0.031 in

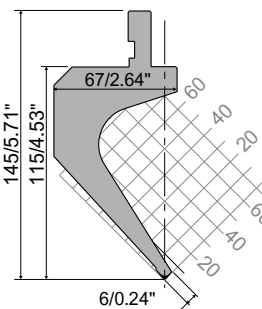

FX: 795 mm - 31.29"

mm: <100-250-20-25-30-35-40-45-50-100-100>
in: <3.94-9.84-0.78-0.98-1.18-1.37-1.57-1.77-1.97-3.94-3.94>



F: 805 mm - 31.69"

mm: <100-370-10-15-20-40-50-100-100>
in: <3.94-14.56-0.39-0.59-0.78-1.57-1.97-3.94-3.94>



P.150.85.R1

835 mm 32.87" 17.5 kg
 415 mm 16.34" 8.7 kg
 795 mm 31.29" 16.6 kg FX
 805 mm 31.69" 16.6 kg F

C45: 560-710 N/mm²
 700 kN/m max.
 Horn 1

85°
 W=120 | H=150 | R=1.0 mm
 W=4.72 | H=5.91 | R=0.039 in

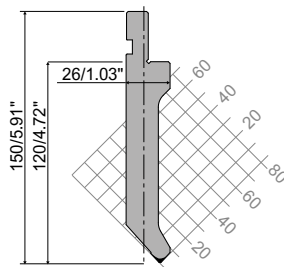

P.250.85.R15

415 mm 16.34" 33.1 kg
 795 mm 31.29" 63.3 kg FX

42Cr: 900-1150 N/mm²
 800 kN/m max.
 Horn 1

85°
 W=220.0 | H=250.0 | R=1.5 mm
 W=8.65 | H=9.84 | R=0.059 in

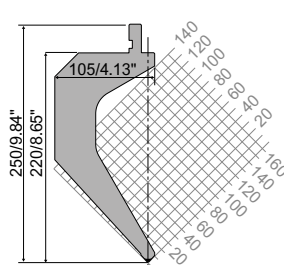

P.97.75.R08

835 mm 32.87" 11 kg
 415 mm 16.34" 5.4 kg
 795 mm 31.29" 10.4 kg FX
 805 mm 31.69" 10.6 kg F

42Cr: 900-1150 N/mm²
 1000 kN/m max.
 Horn 1

75°
 W=67.60 | H=97.60 | R=0.8 mm
 W=2.66 | H=3.84 | R=0.031 in

75° >

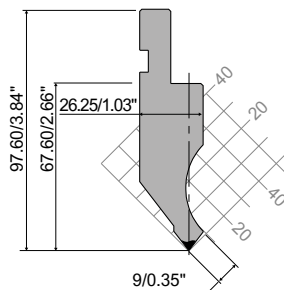

P.135.75.R08

835 mm 32.87" 17.5 kg
 415 mm 16.34" 8.7 kg
 795 mm 31.29" 16.7 kg FX
 805 mm 31.69" 16.9 kg F

42Cr: 900-1150 N/mm²
 1000 kN/m max.
 Horn 1

75°
 W=105 | H=135 | R=0.8 mm
 W= 4.13 | H=5.31 | R=0.031 in

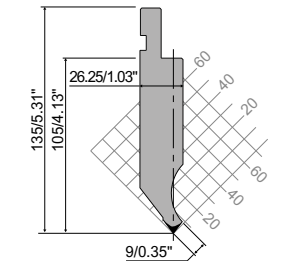

FX: 795 mm - 31.29"

mm: <100-250-20-25-30-35-40-45-50-100-100>
 in: <3.94-9.84-0.78-0.98-1.18-1.37-1.57-1.77-1.97-3.94-3.94>



F: 805 mm - 31.69"

mm: <100-370-10-15-20-40-50-100-100>
 in: <3.94-14.56-0.39-0.59-0.78-1.57-1.97-3.94-3.94>



P.160.70.R08

835 mm	32.87"	18 kg	
415 mm	16.34"	8.9 kg	
795 mm	31.29"	17.0 kg	FX
805 mm	31.69"	17.3 kg	F

70° >

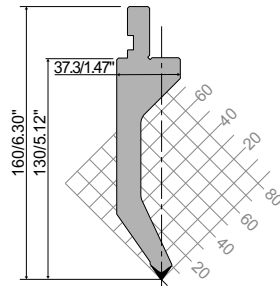

P.160.70.R3

835 mm	32.87"	18 kg	
415 mm	16.34"	8.9 kg	
795 mm	31.29"	17.0 kg	FX
805 mm	31.69"	17.3 kg	F

42Cr: 900-1150 N/mm²
450 kN/m max.
Horn 1

70°
W=130 | H=160 | R=0.8 mm
W=5.12 | H=6.30 | R=0.118 in



P.97.60.R08

835 mm	32.87"	9.0 kg	
415 mm	16.34"	4.5 kg	
795 mm	31.29"	8.5 kg	FX
805 mm	31.69"	8.7 kg	F

60° >

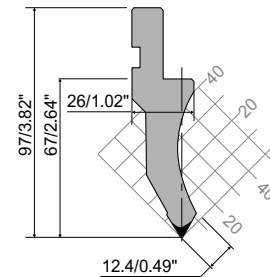

P.97.60.R2

835 mm	32.87"	9.0 kg	
415 mm	16.34"	4.5 kg	
795 mm	31.29"	8.5 kg	FX
805 mm	31.69"	8.7 kg	F

C45: 560-710 N/mm²
600 kN/m max.
Horn 1

60°
W=67 | H=97 | R=0.8 mm
W=2.64 | H=3.82 | R=0.079 in



P.115.60.R08

835 mm	32.87"	11.9 kg	
415 mm	16.34"	5.9 kg	
795 mm	31.29"	10.3 kg	FX
805 mm	31.69"	10.4 kg	F

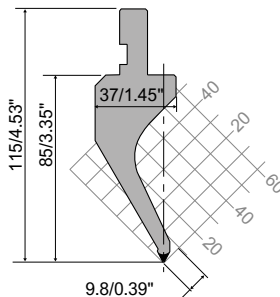

P.135.60.R08

835 mm	32.87"	14.0 kg	
415 mm	16.34"	6.9 kg	
795 mm	31.29"	13.3 kg	FX
805 mm	31.69"	13.5 kg	F

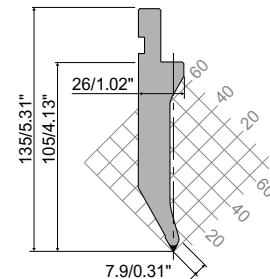

FX: 795 mm - 31.29"

mm: <100-250-20-25-30-35-40-45-50-100-100>
in: <3.94-9.84-0.78-0.98-1.18-1.37-1.57-1.77-1.97-3.94-3.94>

F: 805 mm - 31.69"

mm: <100-370-10-15-20-40-50-100-100>
in: <3.94-14.56-0.39-0.59-0.78-1.57-1.97-3.94-3.94>



PG.135.60.R08

835 mm	32.87"	16.5 kg	
415 mm	16.34"	8.2 kg	
795 mm	31.29"	15.7 kg	FX
805 mm	31.69"	15.9 kg	F

42Cr: 900-1150 N/mm²
700 kN/m max.
Horn 1

60°
W=105 | H=135 | R=0.8 mm
W=4.13 | H=5.31 | R=0.031 in

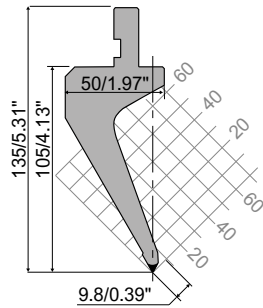

P.145.60.R08

835 mm	32.87"	15.1 kg	
415 mm	16.34"	7.5 kg	
795 mm	31.29"	14.3 kg	FX
805 mm	31.69"	14.5 kg	F

42Cr: 900-1150 N/mm²
700 kN/m max.
Horn 1

60°
W=115.0 | H=145.0 | R=0.8 mm
W=4.53 | H=5.71 | R=0.031 in

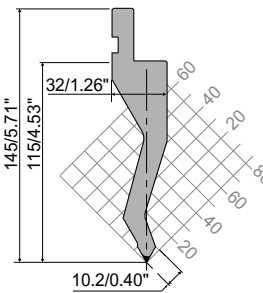

P.190.60.R08

835 mm	32.87"	27.0 kg	
415 mm	16.34"	13.5 kg	
795 mm	31.29"	26.0 kg	FX
805 mm	31.69"	26.1 kg	F

C45: 560-710 N/mm²
400 kN/m max.
Horn 1

60°
W=160 | H=190 | R=0.8 mm
W=7.48 | H=6.30 | R=0.031 in

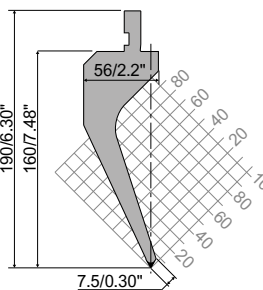

P.95.45.R08

835 mm	32.87"	9.3 kg	
415 mm	16.34"	4.6 kg	
795 mm	31.29"	8.9 kg	FX
805 mm	31.69"	9.0 kg	F

C45: 560-710 N/mm²
800 kN/m max.
Horn 1

45°
W=65.10 | H=95.10 | R=0.8 mm
W=2.56 | H=3.74 | R=0.031 in

45° >

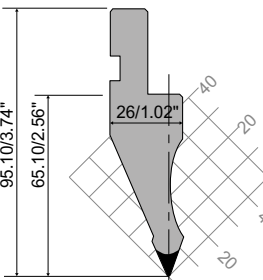

P.95.45.R15

835 mm	32.87"	9.3 kg	
415 mm	16.34"	4.6 kg	
795 mm	31.29"	8.9 kg	FX
805 mm	31.69"	9.0 kg	F

C45: 560-710 N/mm²
800 kN/m max.
Horn 1

45°
W=65.10 | H=95.10 | R=1.5 mm
W=2.56 | H=3.74 | R=0.059 in



FX: 795 mm - 31.29"

mm: <100-250-20-25-30-35-40-45-50-100-100>
in: <3.94-9.84-0.78-0.98-1.18-1.37-1.57-1.77-1.97-3.94-3.94>



F: 805 mm - 31.69"

mm: <100-370-10-15-20-40-50-100-100>
in: <3.94-14.56-0.39-0.59-0.78-1.57-1.97-3.94-3.94>



P.130.45.R6

835 mm	32.87"	19.5 kg	
415 mm	16.34"	9.6 kg	
795 mm	31.29"	18.6 kg	FX
805 mm	31.69"	18.8 kg	F

42Cr: 900-1150 N/mm²
1000 kN/m max.
Horn 1

45°
W=100 | H=130 | R=6 mm
W=3.94 | H=5.12 | R=0.24 in

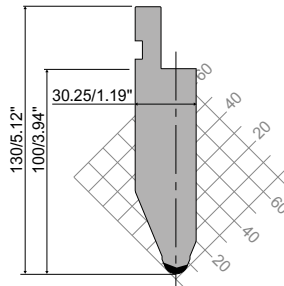

P.97.45.R05

835 mm	32.87"	10.2 kg	
415 mm	16.34"	5.1 kg	
795 mm	31.29"	9.7 kg	FX
805 mm	31.69"	9.8 kg	F
900 mm	35.43"	10.9 kg	

C45: 560-710 N/mm²
800 kN/m max.
Horn 1

45°
W=66.4 | H=96.4 | R=0.5 mm
W=2.61 | H=3.80 | R=0.020 in

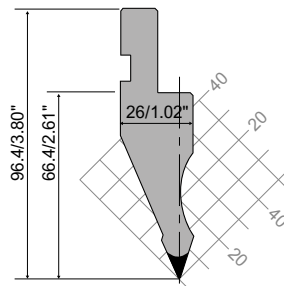

P.95.35.R5

835 mm	32.87"	12.8 kg	
415 mm	16.34"	6.3 kg	
795 mm	31.29"	12.2 kg	FX
805 mm	31.69"	12.3 kg	F

C45: 560-710 N/mm²
1000 kN/m max.
Horn 1

35°
W=65 | H=95 | R=5 mm
W=2.56 | H=3.74 | R=0.20 in

35° >

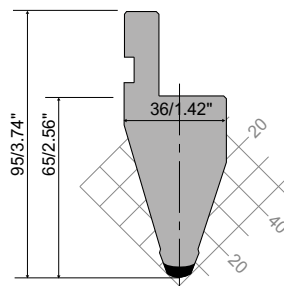

PU.85.35.R08

835 mm	32.87"	11 kg	
415 mm	16.34"	5.5 kg	
795 mm	31.29"	10.5 kg	FX
805 mm	31.69"	10.6 kg	F

42Cr: 900-1150 N/mm²
1000 kN/m max.
Horn 1

35°
W=85 | H=115 | R=0.8 mm
W=3.35 | H=4.53 | R=0.031 in

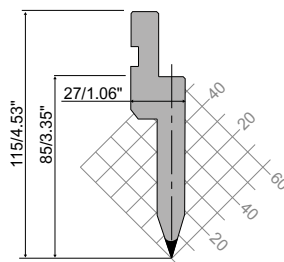

FX: 795 mm - 31.29"

mm: <100-250-20-25-30-35-40-45-50-100-100>
in: <3.94-9.84-0.78-0.98-1.18-1.37-1.57-1.77-1.97-3.94-3.94>



F: 805 mm - 31.69"

mm: <100-370-10-15-20-40-50-100-100>
in: <3.94-14.56-0.39-0.59-0.78-1.57-1.97-3.94-3.94>



P.116.35.R08

835 mm 32.87" 10.7 kg
 415 mm 16.34" 5.3 kg
 795 mm 31.29" 10.2 kg FX
 805 mm 31.69" 10.3 kg F

C45: 560-710 N/mm²
 700 kN/m max.
 Horn 1

35°
 W=86 | H=116 | R=0.8 mm
 W=3.39 | H=4.57 | R=0.031 in

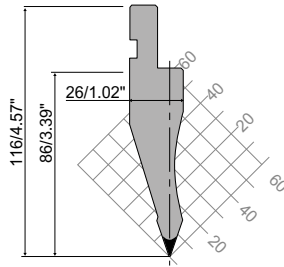

P.116.35.R15

835 mm 32.87" 10.7 kg
 415 mm 16.34" 5.3 kg
 795 mm 31.29" 10.2 kg FX
 805 mm 31.69" 10.3 kg F

C45: 560-710 N/mm²
 700 kN/m max.
 Horn 1

35°
 W=86 | H=116 | R=1.5 mm
 W=3.39 | H=4.57 | R=0.059 in



P.120.35.R08

835 mm 32.87" 12.3 kg
 415 mm 16.34" 6.1 kg
 795 mm 31.29" 11.7 kg FX
 805 mm 31.69" 11.9 kg F

C45: 560-710 N/mm²
 700 kN/m max.
 Horn 1

35°
 W=90 | H=120 | R=0.8 mm
 W=3.54 | H=4.72 | R=0.031 in

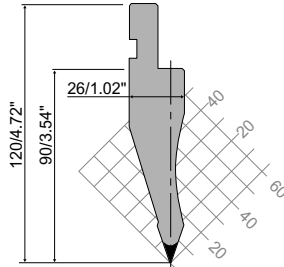

P.120.35.R15

835 mm 32.87" 12.3 kg
 415 mm 16.34" 6.1 kg
 795 mm 31.29" 11.7 kg FX
 805 mm 31.69" 11.9 kg F

C45: 560-710 N/mm²
 700 kN/m max.
 Horn 1

35°
 W=90 | H=120 | R=1.5 mm
 W=3.54 | H=4.72 | R=0.059 in



P.120.35.R3

835 mm 32.87" 12.3 kg
 415 mm 16.34" 6.1 kg
 795 mm 31.29" 11.7 kg FX
 805 mm 31.69" 11.9 kg F

C45: 560-710 N/mm²
 700 kN/m max.
 Horn 1

35°
 W=90 | H=120 | R=3 mm
 W=3.54 | H=4.72 | R=0.018 in

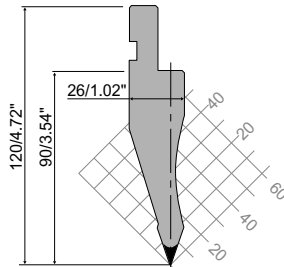

PS.134.30.R08

835 mm 32.87" 13.3 kg
 415 mm 16.34" 6.6 kg
 795 mm 31.29" 12.7 kg FX
 805 mm 31.69" 12.8 kg F

C45: 560-710 N/mm²
 700 kN/m max.
 Horn 1

30°
 W=104 | H=134 | R=0.8 mm
 W=4.09 | H=5.28 | R=0.031 in

30° >

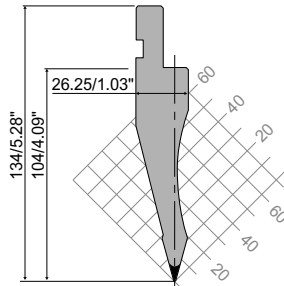

FX: 795 mm - 31.29"

mm: <100-250-20-25-30-35-40-45-50-100-100>
 in: <3.94-9.84-0.78-0.98-1.18-1.37-1.57-1.77-1.97-3.94-3.94>



F: 805 mm - 31.69"

mm: <100-370-10-15-20-40-50-100-100>
 in: <3.94-14.56-0.39-0.59-0.78-1.57-1.97-3.94-3.94>



P.110.30.R06

835 mm	32.87"	10.5 kg	
415 mm	16.34"	5.2 kg	
795 mm	31.29"	10.0 kg	FX
805 mm	31.69"	10.1 kg	F

C45: 560-710 N/mm²
450 kN/m max.
Horn 1

30°
W=80 | H=110 | R=0.6 mm
W=3.15 | H=4.33 | R=0.024 in

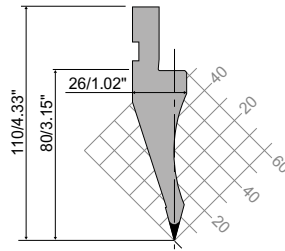

P.147.26.R08

835 mm	32.87"	9.9 kg	
415 mm	16.34"	4.9 kg	
795 mm	31.29"	9.4 kg	FX
805 mm	31.69"	9.6 kg	F

42Cr: 900-1150 N/mm²
500 kN/m max.
Horn 1

26°
W=117 | H=147 | R=0.8 mm
W=4.61 | H=5.79 | R=0.031 in

26° >

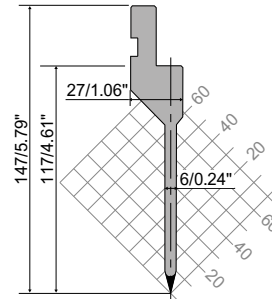

PU.117.26.R08

835 mm	32.87"	13.6 kg	
415 mm	16.34"	6.7 kg	
795 mm	31.29"	12.9 kg	FX
805 mm	31.69"	13.1 kg	F

C45: 560-710 N/mm²
1000 kN/m max.
Horn 1

26°
W=117.0 | H=147.0 | R=0.8 mm
W=4.61 | H=5.79 | R=0.031 in

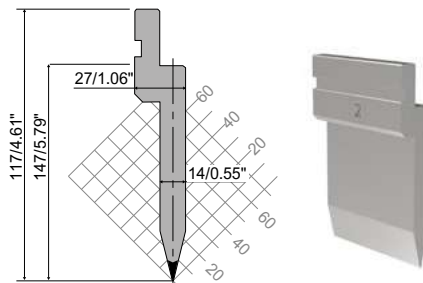

PU.117.26.R3

835 mm	32.87"	13.6 kg	
415 mm	16.34"	6.7 kg	
795 mm	31.29"	12.9 kg	FX
805 mm	31.69"	13.1 kg	F

C45: 560-710 N/mm²
1000 kN/m max.
Horn 1

26°
W=109.0 | H=139.0 | R=3 mm
W=4.29 | H=5.47 | R=0.118 in

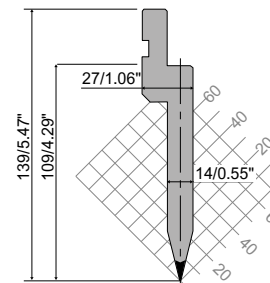

PU.150.26.R08.L

900 mm	35.43"	15.2 kg	
415 mm	16.34"	7.0 kg	
795 mm	31.29"	13.4 kg	FX
805 mm	31.69"	13.6 kg	F

C45: 560-710 N/mm²
1000 kN/m max.
Horn 1

26°
W=120 | H=150 | R=0.8 mm
W=4.72 | H=5.91 | R=0.031 in

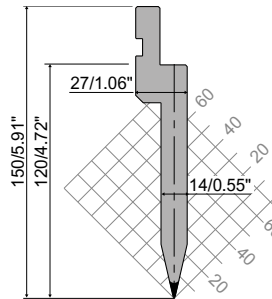

FX: 795 mm - 31.29"

mm: <100-250-20-25-30-35-40-45-50-100-100>
in: <3.94-9.84-0.78-0.98-1.18-1.37-1.57-1.77-1.97-3.94-3.94>

F: 805 mm - 31.69"

mm: <100-370-10-15-20-40-50-100-100>
in: <3.94-14.56-0.39-0.59-0.78-1.57-1.97-3.94-3.94>



SCA.M.90.R08



Per pair 3.5 kg

90° >

C45: 560-710 N/mm²
150 kN/m max.

90°

H=66.35 | R=0.8 mm
H=2.61 | R=0.031 in

1 pair L/R compatible with
PK.97.90.R08

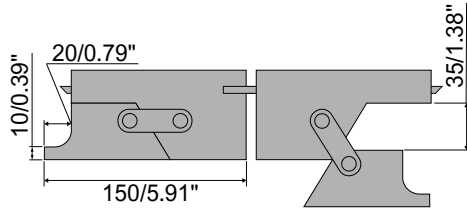

SCA.M.90.R025



Per pair 3.5 kg

C45: 560-710 N/mm²
150 kN/m max.

90°

H=66.60 | R=0.25 mm
H=2.62 | R=0.010 in

1 pair L/R compatible with
PK.97.90.R025

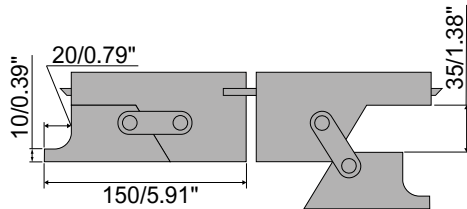

SCA.M.88.R08



Per pair 3.5 kg

88° >

C45: 560-710 N/mm²
150 kN/m max.

88°

H=66.65 | R=0.8 mm
H=2.62 | R=0.031 in

1 pair L/R compatible with
P.97.88.R08

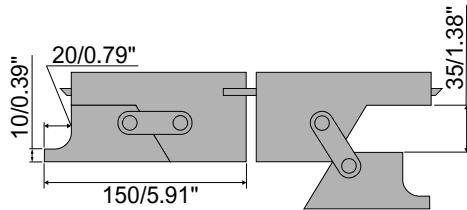

SCA.M.88.R025



Per pair 3.5 kg

C45: 560-710 N/mm²
150 kN/m max.

88°

H=66.60 | R=0.25 mm
H=2.62 | R=0.010 in

1 pair L/R compatible with
PK.97.88.R025

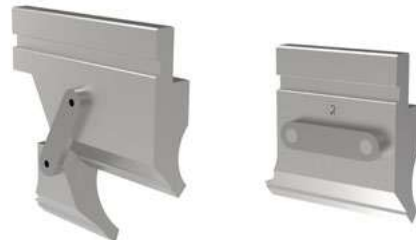
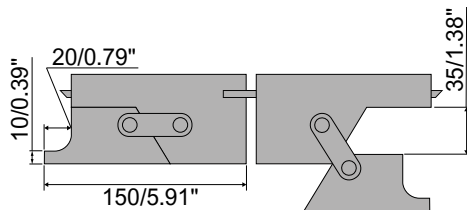

Movable horns are equipped with a swivel pin, which enables the rotation of the horn tip downwards and consequently reduces its length.

During the bending process keep movable horn closed and activate the swivel pin only to remove the bent profile easily and quickly.

Can be produced for these Rolleri R1 tool models:

88°	85°	70°	60°	26°
P97.88.R06	TOP.175.85.R08	P.160.70.R08	P.135.60.R08	PU.117.26.R08
P97.88.R08	TOP.205.85.R08		P.145.60.R08	TOP.205.26.R08
P.130.88.R08			TOP.175.60.R08	TOP.175.26.R08
P.150.88.R08				

SPE.11

7.0 kg

42Cr: 900-1150 N/mm²
150 kN/m max.

88°

W=110 | H=140 | R=0.8 mm

W=4.33 | H=5.51 | R=0.031 in

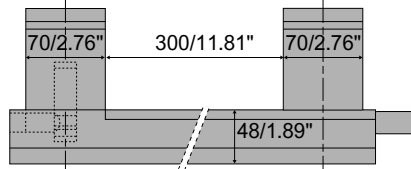
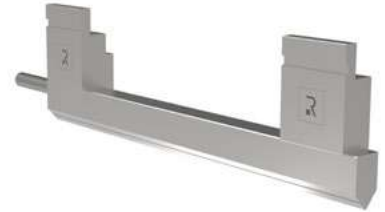
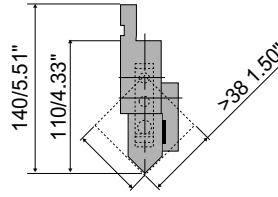

JOGGLE TOOL INSERTS

	Z	Z	α	Thickness !		835 mm	415 mm	
				mm	in			
CEZ 1.0	1	0.04	160°	1.2	0.05	11 kg	5.5 kg	
CEZ 1.5	1.5	0.06	160°	1.5	0.06	11 kg	5.5 kg	160°
CEZ 2.0	2	0.08	150°	1.4	0.06	11 kg	5.5 kg	150°
CEZ 2.5	2.5	0.10	140°	1.3	0.05	11 kg	5.5 kg	140°
CEZ 1.0/90	1	0.04	90°	0.3	0.01	11 kg	5.5 kg	
CEZ 1.5/90	1.5	0.06	90°	0.3	0.01	11 kg	5.5 kg	
CEZ 2.0/90	2	0.08	90°	0.4	0.02	11 kg	5.5 kg	
CEZ 2.5/90	2.5	0.10	90°	0.5	0.02	11 kg	5.5 kg	
CEZ 3.0	3	0.12	90°	1.0	0.04	10.3 kg	5.1 kg	
CEZ 3.5	3.5	0.14	90°	1.0	0.04	10 kg	5 kg	
CEZ 4.0	4	0.16	90°	1.2	0.05	10 kg	5 kg	
CEZ 4.5	4.5	0.18	90°	1.2	0.05	10 kg	5 kg	90°
CEZ 5.0	5	0.20	90°	1.3	0.05	10 kg	5 kg	
CEZ 5.5	5.5	0.22	90°	1.4	0.06	10 kg	5 kg	
CEZ 6.0	6	0.24	90°	1.5	0.06	10 kg	5 kg	
CEZ 6.5	6.5	0.26	90°	1.5	0.06	10 kg	5 kg	
CEZ 7.0	7	0.28	90°	1.5	0.06	10 kg	5 kg	
CEZ 7.5	7.5	0.30	90°	1.6	0.06	10 kg	5 kg	
CEZ 8.0	8	0.31	90°	1.6	0.06	10 kg	5 kg	
CEZ 9.0	9	0.35	90°	1.8	0.07	13.5 kg	6.5 kg	
CEZ 10.0	10	0.39	90°	1.8	0.07	13.5 kg	5 kg	
CEZ 11.0	11	0.43	90°	2	0.08	13.5 kg	5 kg	
CEZ 12.0	12	0.47	90°	2	0.08	13.5 kg	5 kg	90°
CEZ 13.0	13	0.51	90°	2	0.08	13.5 kg	5 kg	
CEZ 14.0	14	0.55	90°	2	0.08	13.5 kg	5 kg	
CEZ 15.0	15	0.59	90°	2.3	0.09	13.5 kg	5 kg	

C45: 560-710 N/mm²
1000 kN/m max.

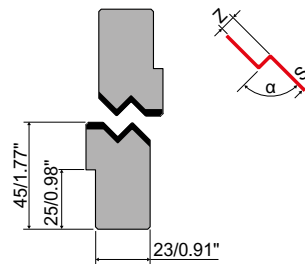
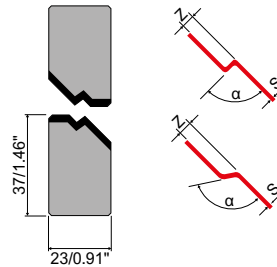

! Z dimensions and angles mentioned in the above table are valid only to bend mild steel with max. tensile strength 420 N/mm².

If you have to bend other sheet metal types, please contact our technical department at engineer@rolleritools.com

Joggle tools can make two bends at the same time, so the bending process is extremely quick. Furthermore, it is very flexible and convenient, as by using the same CPZ holder you can produce 15 different joggles by changing inserts only. By using CEZ inserts, the bending result is guaranteed.



Request our clamping, punching and ironworker, consumables laser, panel bending tools and shear blades catalogues on www.rolleritools.com/download

CPZ

835 mm 32.87" 37.5 kg
415 mm 16.34" 18.7 kg

C45: 560-710 N/mm²
1000 kN/m max.

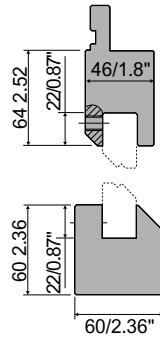

PU.67.14-S

830 mm 32.68" 9.7 kg
410 mm 16.14" 5 kg

C45: 560-710 N/mm²
400 kN/m max.

W=67 | H=97 mm
W=2.64 | H=3.82 in

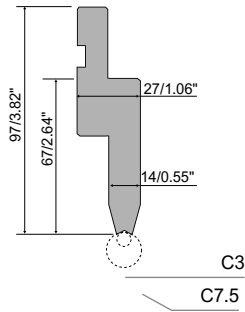

C3 - C7.5

	R	R	835 mm	415 mm
	mm	in	32.87 in	16.34 in
C3	3.0	0.12	0.20 kg	0.10 kg
C3.5	3.5	0.14	0.20 kg	0.10 kg
C4	4.0	0.16	0.35 kg	0.17 kg
C4.5	4.5	0.18	0.50 kg	0.25 kg
C5	5.0	0.20	0.60 kg	0.30 kg
C5.5	5.5	0.22	0.70 kg	0.35 kg
C6	6.0	0.24	0.80 kg	0.40 kg
C6.5	6.5	0.26	1.00 kg	0.50 kg
C7	7.0	0.28	0.80 kg	0.40 kg
C7.5	7.5	0.30	1.00 kg	0.50 kg

C45: 560-710 N/mm²
400 kN/m max.

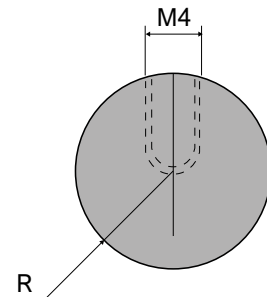

Create your account on www.rolleritools.com
You can use Rolleri website to check the delivery time, request quotes, stay update with the news, check prices and place orders directly.



Download Rolleri **BENDING APP**.

You will have access to our online store where you can get what you need. You will also get our sheet metal unfolding software for free and our bending rule.

PU.67.14

830 mm 32.68" 9 kg
410 mm 16.14" 5 kg

C45: 560-710 N/mm²
800 kN/m max.

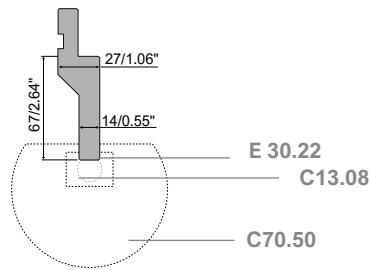

PU.87.14

830 mm 32.68" 9 kg
412 mm 16.22" 4.5 kg

42Cr: 900-1150 N/mm²
500 kN/m max.

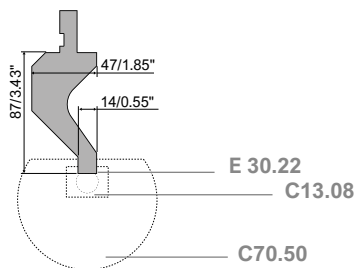

PU.105.14

830 mm 32.68" 12 kg
412 mm 16.22" 6 kg

C45: 560-710 N/mm²
800 kN/m max.

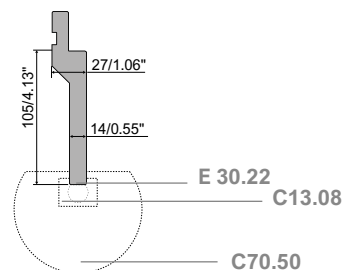

PU.115.14

830 mm 32.68" 26 kg
412 mm 16.22" 13 kg

C45: 560-710 N/mm²
500 kN/m max.

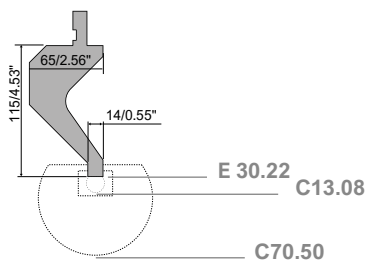

The same holder can be equipped with different radius tools and, in case of PU67.14 and PU105.14, also with E30.22 flat hemming insert to flatten thick sheet metal.

Radius profiles bent with radius tools show a more regular shape and therefore they aesthetically look better.

PU holders and C radius tools have been designed to guarantee the

maximum flexibility thanks to the wide range of different radius tools which can be used. For specific needs the same concept can be used for special shapes like U shapes, omega etc..

The assembly system has been studied in order to be flexible and to guarantee the easy and quick radius tool change.

RADIUS TOOLS Ø 16 - 20

	R	R	H	H	A	A	835 mm	415 mm
	mm	in	mm	in	mm	in	32.87 in	16.34 in
C13.08	8	0.31	13	0.51	-	-	2.0 kg	1.0 kg
C13.09	9	0.35	16	0.63	-	-	2.0 kg	1.0 kg
C16.10	10	0.39	16	0.63	-	-	2.0 kg	1.0 kg

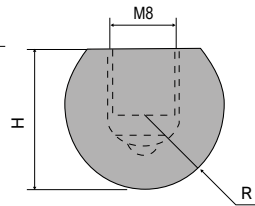

RADIUS TOOLS Ø 25 - 100

	R	R	W	W	H	H	835 mm	415 mm
	mm	in	mm	in	mm	in	32.87 in	16.34 in
C17.12	12.5	0.49	17	0.67	22	0.87	2.5 kg	1.2 kg
C20.15	15	0.59	20	0.79	27	1.06	3.7 kg	1.8 kg
C22.17	17.5	0.69	22	0.87	32	1.26	5.0 kg	2.4 kg
C24.20	20	0.79	24	0.94	34	1.33	7.0 kg	3.5 kg
C25.22	22.5	0.89	25	0.98	35	1.38	7.5 kg	3.8 kg
C29.25	25	0.98	29	1.14	39	1.53	10.0 kg	4.7 kg
C34.27	27.5	1.08	34	1.33	44	1.73	12.4 kg	6.2 kg
C34.30	30	1.18	34	1.33	44	1.73	13.5 kg	6.7 kg
C37.32	32.5	1.28	37	1.46	47	1.85	15.9 kg	7.9 kg
C45.35	35	1.38	45	1.77	55	2.16	20.3 kg	10.0 kg
C42.37	37.5	1.48	42	1.65	52	2.04	20.5 kg	10.3 kg
C45.40	40	1.57	45	1.77	55	2.16	23.0 kg	11.5 kg
C60.45	22.5	0.89	60	2.36	70	2.75	34.0 kg	17.0 kg
C70.50	50	1.97	70	2.75	80	3.15	43.5 kg	21.7 kg

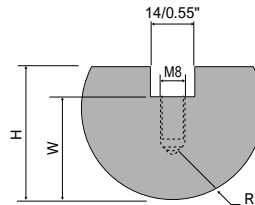

Hemming tools CLASSIC serie

E30.22

830 mm	32.68"	3.5 kg
412 mm	16.22"	1.7 kg



C45: 560-710 N/mm²
800 kN/m max.

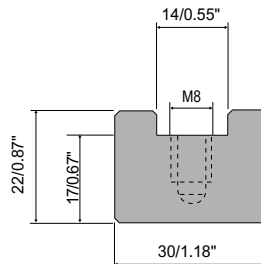

Create your account on www.rolleritools.com
You can use Rolleri website to check the delivery time, request quotes, stay update with the news, check prices and place orders directly.



The **Bending handbook** target is to supply practice and useful information to reach quickly the required result. A lot of examples, easy formulas and information which explain the proper attitude towards the bending process.

00402

835 mm 32.87" 11 kg
 415 mm 16.34" 5.5 kg
 795 mm 31.29" 10.5 kg FX
 835 mm 32.87" 11 kg FCA

C45: 560-710 N/mm²
 1000 kN/m max.
 Horn 3

88°
 W=66.9 | H=96.9 | R=0.2 mm
 W=2.63 | H=3.81 | R=0.008 in

88-90° >

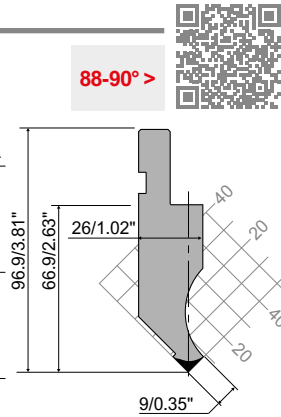

01602

835 mm 32.87" 11 kg
 415 mm 16.34" 5.5 kg
 795 mm 31.29" 10.5 kg FX
 835 mm 32.87" 11 kg FCA

C45: 560-710 N/mm²
 1000 kN/m max.
 Horn 3

90°
 W=66.92 | H=96.92 | R=0.2 mm
 W=2.63 | H=3.81 | R=0.118 in

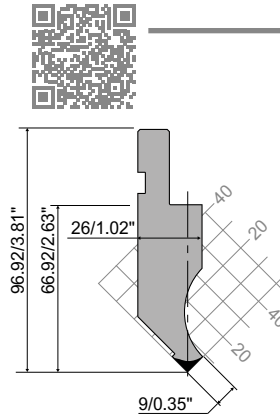

00430

835 mm 32.87" 11 kg
 415 mm 16.34" 5.5 kg
 795 mm 31.29" 10.5 kg FX
 835 mm 32.87" 11 kg FCA

C45: 560-710 N/mm²
 1000 kN/m max.
 Horn 3

88°
 W=65.68 | H=95.68 | R=3 mm
 W=2.59 | H=3.77 | R=0.118 in

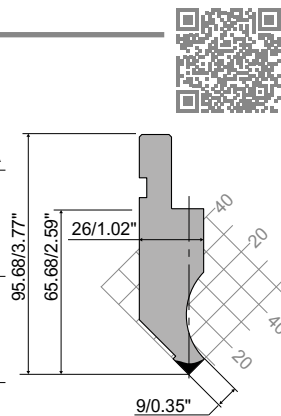

01630

835 mm 32.87" 11 kg
 415 mm 16.34" 5.5 kg
 795 mm 31.29" 10.5 kg FX
 835 mm 32.87" 11 kg FCA

C45: 560-710 N/mm²
 1000 kN/m max.
 Horn 3

90°
 W=65.6 | H=95.6 | R=3 mm
 W=2.58 | H=3.76 | R=0.118 in

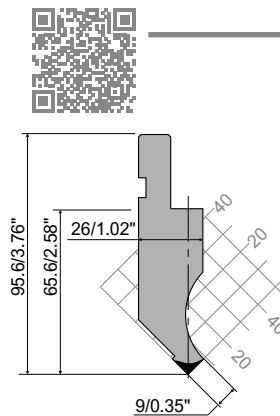

11700

835 mm 32.87" 10.7 kg
 415 mm 16.34" 5.3 kg
 795 mm 31.29" 10.3 kg FX
 800 mm 32.87" 10.3 kg FC

42Cr: 900-1150 N/mm²
 200 kN/m max.
 Horn 7

88°
 W=66.91 | H=96.91 | R=0.2 mm
 W=2.63 | H=3.81 | R=0.008 in

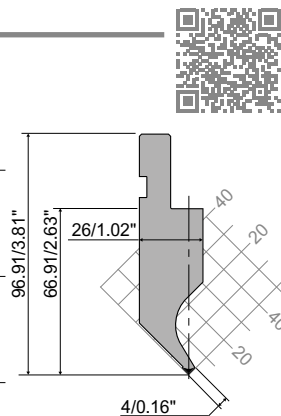

11600

835 mm 32.87" 11 kg
 415 mm 16.34" 5.5 kg
 795 mm 31.29" 10.1 kg FX
 800 mm 32.87" 11 kg FC

42Cr: 900-1150 N/mm²
 200 kN/m max.
 Horn 7

90°
 W=66.90 | H=96.90 | R=0.2 mm
 W=2.63 | H=3.81 | R=0.008 in

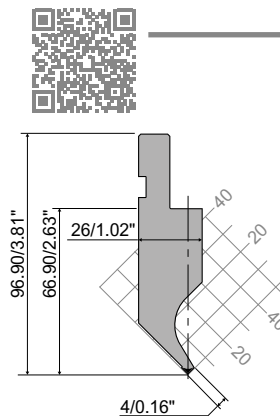

04502

835 mm 32.87" 22.0 kg
 415 mm 16.34" 10.9 kg
 795 mm 31.29" 22.0 kg FX
 835 mm 32.87" 22.0 kg FCA

42Cr: 900-1150 N/mm²
 500 kN/m max.
 Horn 3

88°
 W=104.91 | H=134.91 | R=0.2 mm
 W=4.13 | H=5.31 | R=0.008 in

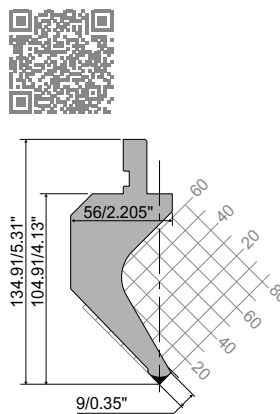

04600

835 mm 32.87" 22.0 kg
 415 mm 16.34" 11.0 kg
 795 mm 31.29" 21.0 kg FX
 835 mm 32.87" 22.0 kg FCA

42Cr: 900-1150 N/mm²
 500 kN/m max.
 Horn 3

90°
 W=104.91 | H=134.9 | R=0.2 mm
 W=4.13 | H=5.31 | R=0.008 in

FX: 795 mm - 31.29"

mm: <100-250-20-25-30-35-40-45-50-100-100>

in: <3.94-9.84-0.78-0.98-1.18-1.37-1.57-1.77-1.97-3.94-3.94>

FCA: 835 mm - 32.87"

mm: <100-10-15-20-40-50-200-300-100>

in: <3.94-0.39-0.59-0.78-1.57-7.87-11.81-3.94>

FC: 800 mm - 31.50"

mm: <100-10-15-20-40-50-165-300-100>

in: <3.94-0.39-0.59-0.78-1.57-1.97-6.49-11.81-3.94>





45202

835 mm 32.87" 19.6 kg
 415 mm 16.34" 9.7 kg
 795 mm 31.29" 18.9 kg FX
 835 mm 32.87" 19.6 kg FCA

42Cr: 900-1150 N/mm²
 700 kN/m max.
 Horn 3

88°
 W=89.91 | H=119.91 | R=0.2 mm
 W=3.54 | H=4.72 | R=0.008 in

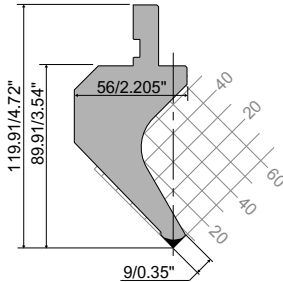

46200

835 mm 32.87" 19.6 kg
 415 mm 16.34" 9.8 kg
 795 mm 31.29" 18.7 kg FX
 835 mm 32.87" 19.6 kg FCA

42Cr: 900-1150 N/mm²
 700 kN/m max.
 Horn 3

90°
 W=89.91 | H=119.91 | R=0.2 mm
 W=3.54 | H=4.72 | R=0.008 in

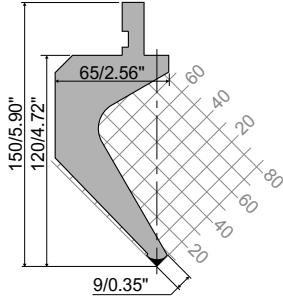

04702

835 mm 32.87" 25.8 kg
 415 mm 16.34" 12.9 kg
 795 mm 31.29" 24.6 kg FX
 835 mm 32.87" 25.8 kg FCA

42Cr: 900-1150 N/mm²
 500 kN/m max.
 Horn 3

88°
 W=120 | H=150 | R=0.2 mm
 W=4.72 | H=5.90 in | R=0.008 in

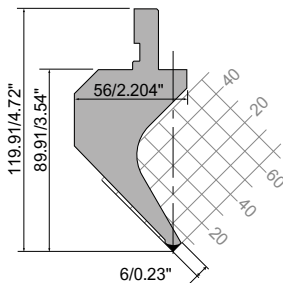

04800

835 mm 32.87" 25.8 kg
 415 mm 16.34" 12.9 kg
 795 mm 31.29" 24.6 kg FX
 835 mm 32.87" 25.8 kg FCA

42Cr: 900-1150 N/mm²
 500 kN/m max.
 Horn 3

90°
 W=120 | H=150 | R=0.2 mm
 W=4.72 | H=5.90 | R=0.008 in

45302

835 mm 32.87" 18.6 kg
 415 mm 16.34" 9.3 kg
 795 mm 31.29" 17.7 kg FX
 835 mm 32.87" 18.6 kg FCA

42Cr: 900-1150 N/mm²
 500 kN/m max.
 Horn 7

88°
 W=89.91 | H=119.91 | R=0.2 mm
 W=3.54 | H=4.72 | R=0.008 in

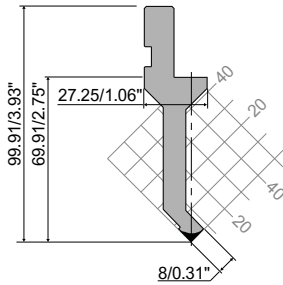

46300

835 mm 32.87" 18.6 kg
 415 mm 16.34" 9.3 kg
 795 mm 31.29" 17.7 kg FX
 835 mm 32.87" 18.6 kg FCA

42Cr: 900-1150 N/mm²
 500 kN/m max.
 Horn 7

90°
 W=89.91 | H=119.91 | R=0.2 mm
 W=3.54 | H=4.72 | R=0.008 in

20000

835 mm 32.87" 7.9 kg
 415 mm 16.34" 3.9 kg
 795 mm 31.29" 7.5 kg FX
 800 mm 32.87" 7.5 kg FC

42Cr: 900-1150 N/mm²
 300 kN/m max.
 Horn 4

88°
 W=69.91 | H=99.91 | R=0.2 mm
 W=2.75 | H=3.93 in | R=0.008 in

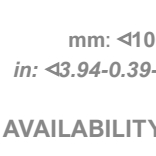
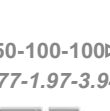

20100

835 mm 32.87" 7.9 kg
 415 mm 16.34" 3.9 kg
 795 mm 31.29" 7.6 kg FX
 800 mm 32.87" 7.6 kg FC

42Cr: 900-1150 N/mm²
 300 kN/m max.
 Horn 4

90°
 W=69.91 | H=99.91 | R=0.2 mm
 W=2.75 | H=3.93 in | R=0.008 in

FX: 795 mm - 31.29"

mm: <100-250-20-25-30-35-40-45-50-100-100>

in: <3.94-9.84-0.78-0.98-1.18-1.37-1.57-1.77-1.97-3.94-3.94>

FCA: 835 mm - 32.87"

mm: <100-10-15-20-40-50-200-300-100>

in: <3.94-0.39-0.59-0.78-1.57-7.87-11.81-3.94>

FC: 800 mm - 31.50"

mm: <100-10-15-20-40-50-165-300-100>

in: <3.94-0.39-0.59-0.78-1.57-1.97-6.49-11.81-3.94>



20200

835 mm	32.87"	10.0 kg	
415 mm	16.34"	5.0 kg	
795 mm	31.29"	9.5 kg	FX
800 mm	31.50"	9.6 kg	FC

42Cr: 900-1150 N/mm²
300 kN/m max.
Horn 4

88°
W=99.91 | H=129.91 | R=0.2 mm
W=3.93 | H=5.11 | R=0.008 in

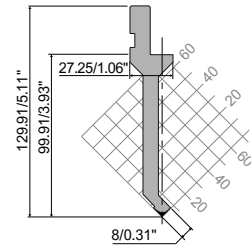

20300

835 mm	32.87"	10.0 kg	
415 mm	16.34"	5.0 kg	
795 mm	31.29"	9.5 kg	FX
800 mm	31.50"	9.6 kg	FC

42Cr: 900-1150 N/mm²
300 kN/m max.
Horn 4

90°
W=99.91 | H=129.91 | R=0.2 mm
W=3.93 | H=5.11 | R=0.118 in



00480

835 mm	32.87"	11.0 kg	
415 mm	16.34"	5.5 kg	
795 mm	31.29"	10.5 kg	FX
835 mm	31.50"	11.0 kg	FCA

C45: 560-710 N/mm²
1000 kN/m max.
Horn 3

88°
W=66.91 | H=96.91 | R=0.2 mm
W=2.63 | H=3.82 | R=0.008 in

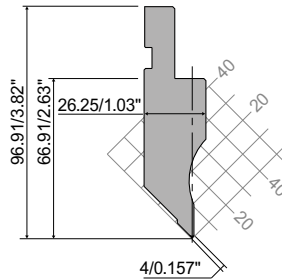

01680

835 mm	32.87"	10.7 kg	
415 mm	16.34"	5.5 kg	
795 mm	31.29"	10.2 kg	FX
835 mm	31.50"	10.7 kg	FCA

C45: 560-710 N/mm²
400 kN/m max.
Horn 3

90°
W=66.91 | H=96.91 | R=0.2 mm
W=2.63 | H=3.82 | R=0.008 in



00490

835 mm	32.87"	11.0 kg	
415 mm	16.34"	5.5 kg	
795 mm	31.29"	10.5 kg	FX
835 mm	31.50"	11.0 kg	FCA

C45: 560-710 N/mm²
800 kN/m max.
Horn 3

88°
W=66.91 | H=96.91 | R=0.2 mm
W=2.63 | H=3.82 | R=0.008 in

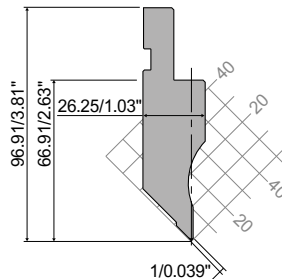

01690

835 mm	32.87"	11.0 kg	
415 mm	16.34"	5.5 kg	
795 mm	31.29"	10.5 kg	FX
835 mm	31.50"	11.0 kg	FCA

C45: 560-710 N/mm²
800 kN/m max.
Horn 3

90°
W=66.91 | H=96.91 | R=0.2 mm
W=2.63 | H=3.82 | R=0.008 in



10900

835 mm	32.87"	9.0 kg	
415 mm	16.34"	4.5 kg	
795 mm	31.29"	8.5 kg	FX
835 mm	31.50"	9.0 kg	FCA

42Cr: 900-1150 N/mm²
500 kN/m max.
Horn 4

88°
W=94.91 | H=124.91 | R=0.2 mm
W=3.74 | H=4.92 | R=0.008 in

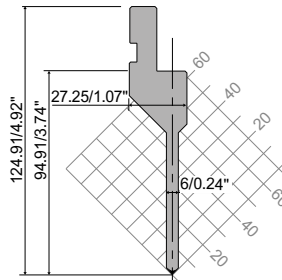

10800

835 mm	32.87"	11.0 kg	
415 mm	16.34"	5.5 kg	
795 mm	31.29"	8.5 kg	FX
835 mm	31.50"	11.0 kg	FCA

42Cr: 900-1150 N/mm²
500 kN/m max.
Horn 4

90°
W=94.91 | H=124.91 | R=0.2 mm
W=3.74 | H=4.92 | R=0.008 in



FX: 795 mm - 31.29"

mm: <100-250-20-25-30-35-40-45-50-100-100>
in: <3.94-9.84-0.78-0.98-1.18-1.37-1.57-1.77-1.97-3.94-3.94>

FCA: 835 mm - 32.87"

mm: <100-10-15-20-40-50-200-300-100>
in: <3.94-0.39-0.59-0.78-1.57-7.87-11.81-3.94>

FC: 800 mm - 31.50"

mm: <100-10-15-20-40-50-165-300-100>
in: <3.94-0.39-0.59-0.78-1.57-1.97-6.49-11.81-3.94>



10906

835 mm 32.87" 9.0 kg
 415 mm 16.34" 4.5 kg
 795 mm 31.29" 8.5 kg FX
 835 mm 31.50" 9.0 kg FCA

42Cr: 900-1150 N/mm²

500 kN/m max.

Horn 4

88°

W=94.74 | H=124.74 | R=0.6 mm

W=3.73 | H=4.91 | R=0.024 in

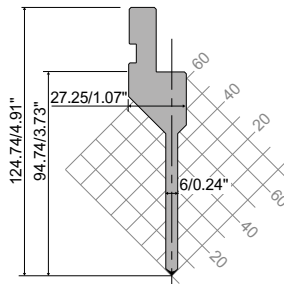

00300

835 mm 32.87" 15.0 kg
 415 mm 16.34" 7.5 kg
 795 mm 31.29" 14.4 kg FX
 835 mm 31.50" 15.0 kg FCA

C45: 560-710 N/mm²

1000 kN/m max.

Horn 6

60°

W=65 | H=95 | R=0.6 mm

W=2.56 | H=3.74 in | R=0.002 in

60° >

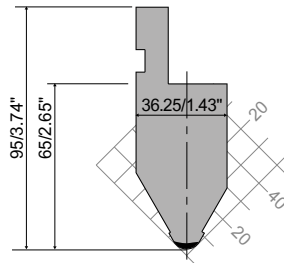

00800

835 mm 32.87" 9.3 kg
 415 mm 16.34" 4.6 kg
 795 mm 31.29" 9.3 kg FX
 835 mm 31.50" 9.3 kg FCA

C45: 560-710 N/mm²

600 kN/m max.

Horn 5

45°

W=66.4 | H=96.4 | R=0.37 mm

W=2.61 | H=3.79 | R=0.015 in

45° >

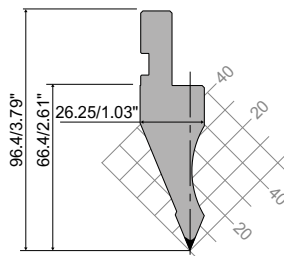

21000

835 mm 32.87" 15.3 kg
 415 mm 16.34" 7.6 kg
 795 mm 31.29" 14.5 kg FX
 800 mm 31.50" 14.6 kg FC

42Cr: 900-1150 N/mm²

1000 kN/m max.

Horn 5

30°

W=104 | H=134 | R=0.65 mm

W=4.09 | H=5.27 | R=0.025 in

30° >

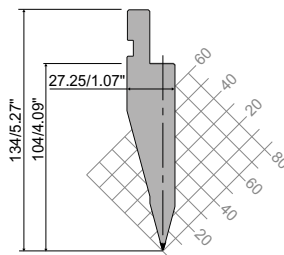

FX: 795 mm - 31.29"

mm: <100-250-20-25-30-35-40-45-50-100-100>

in: <3.94-9.84-0.78-0.98-1.18-1.37-1.57-1.77-1.97-3.94-3.94>

FCA: 835 mm - 32.87"

mm: <100-10-15-20-40-50-200-300-100>

in: <3.94-0.39-0.59-0.78-1.57-7.87-11.81-3.94>

FC: 800 mm - 31.50"

mm: <100-10-15-20-40-50-165-300-100>

in: <3.94-0.39-0.59-0.78-1.57-1.97-6.49-11.81-3.94>



10300

835 mm	32.87"	11 kg	
415 mm	16.34"	5.5 kg	
795 mm	31.29"	10.4 kg	FX
800 mm	31.50"	10.5 kg	FC

42Cr: 900-1150 N/mm²
 1000 kN/m max.
 Horn 5

30°
 W=67 | H=97 | R=0.52 mm
 W=2.64 | H=3.81 | R=0.020 in

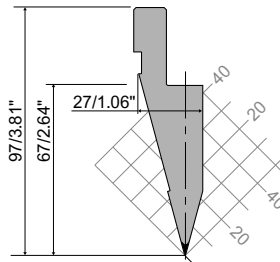

Punches CFH serie

Rolleri offers you fixed height solution compatible with Amada and other European Fixed Height press brake tool styles.

We offer the best solution in shapes, guaranteeing to increase flexibility of your press brake.

All Rolleri tools are state of the art manufactured to ensure precision bending. Using only best quality steels on the market and applying induction deep hardening up to 60 Hrc we provide tools that align

with a tolerance of +/- .0004" - 0,01 mm and have the longest working lifetime in the market. Rolleri provides best standard solutions based in 30 years experience in over 65 countries around the globe.

We also manufacture custom solutions for any bending needs and applications guarantee always the best quality and precision on each and every single one of our tools.

Available on request:

510 mm | 20.08"

200 mm | 7.87"

370 mm | 14.57" mm: 100-300-150-50-40-20-15-15-10-100
 in: 3.94-11.81-5.90-1.96-1.57-0.79-0.59-0.59-0.39-3.94

200 mm | 7.87" 100 Left horn -100 Right horn

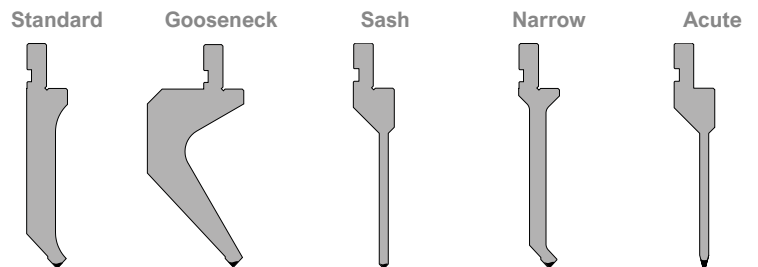

CFH150.86.R02-STD

835 mm	32.87"	17.5 kg	
415 mm	16.34"	8.7 kg	
800 mm	31.49"	16.8 kg	F

42Cr: 900-1150 N/mm²
 1000 kN/m max.
 Horn 1

86°
 W=120 | H=150 | R=0.2 mm
 W=4.72 | H=5.91 | R=0.008 in

Also available W=85 3.35
! NEW

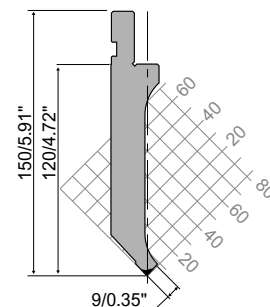

FX: 795 mm - 31.29"

mm: <100-250-20-25-30-35-40-45-50-100-100>
 in: <3.94-9.84-0.78-0.98-1.18-1.37-1.57-1.77-1.97-3.94-3.94>

FC: 800 mm - 31.50"

mm: <100-10-15-20-40-50-165-300-100>
 in: <3.94-0.39-0.59-0.78-1.57-1.97-6.49-11.81-3.94>

F: 800 mm - 31.49"

mm: <100-300-150-50-40-20-15-15-10-100>
 in: <3.94-11.81-5.90-1.96-1.57-0.79-0.59-0.59-0.39-3.94>



CFH150.86.R02-GNK

835 mm 32.87" 25.2 kg
 415 mm 16.34" 12.5 kg
 800 mm 31.49" 24.2 kg F

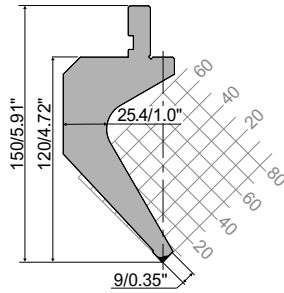

42Cr: 900-1150 N/mm²
 500 kN/m max.
 Horn 1

86°
 W=120 | H=150 | R=0.2 mm
 W=4.72 | H=5.91 | R=0.008 in

Also available W=85 3.35
NEW

CFH150.86.R02-SSH

835 mm 32.87" 11.8 kg
 415 mm 16.34" 5.9 kg
 800 mm 31.49" 11.3 kg F

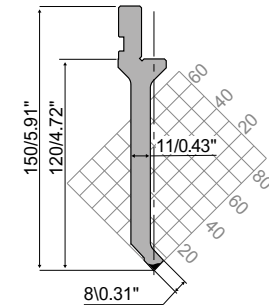

42Cr: 900-1150 N/mm²
 500 kN/m max.
 Horn 1

86°
 W=120 | H=150 | R=0.65 mm
 W=4.72 | H=5.91 | R=0.025 in

Also available W=85 3.35
NEW

CFH.150.88.R025

835 mm 32.87" 17.5 kg
 415 mm 16.34" 8.7 kg
 800 mm 31.49" 16.9 kg F

88° >

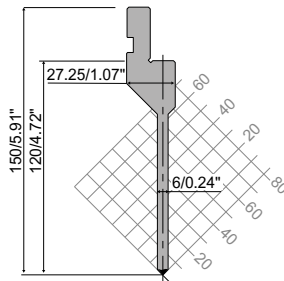

42Cr: 900-1150 N/mm²
 500 kN/m max.
 Horn 1

88°
 W=120 | H=150 | R=0.37 mm
 W=4.72 | H=5.91 | R=0.015 in

Also available W=85 3.35

CFH.150.30.R08

835 mm 32.87" 17.5 kg
 415 mm 16.34" 8.7 kg
 800 mm 31.49" 16.9 kg F

30° >

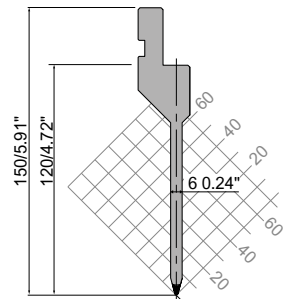

42Cr: 900-1150 N/mm²
 500 kN/m max.
 Horn 1

30°
 W=120 | H=150 | R=0.8 mm
 W=4.72 | H=5.91 | R=0.031 in

Also available W=85 3.35

F: 800 mm - 31.49"

mm: <100-300-150-50-40-20-15-15-10-100>

in: <3.94-11.81-5.90-1.96-1.57-0.79-0.59-0.59-0.39-3.94>



Download Rolleri BENDING APP.



You will have access to our online store where you can get what you need. You will also get our sheet metal unfolding software for free and our bending rule.

R1

DIES

Accurl, Accurpress, ACL, Adira, Amada, Atlantic, Baykal, BL, Boschert, Boutillon, Bystronic Beyeler, Euro-B, Coastone, Colgar, Dener, Deratech, Durmazlar, Ermaksan, Farina, Gade, Gasparini, Gecko, Gilardi, Gizelis, Haco, Hindustan, HPM, Iturrospe, Jfy, JMT, LFK, Metfab, MVD, Oriance, Prima Power, Promecam, Rico, Salvagnini, Schiavi, SMD, Sorg, Somo, Vicla, Vimercati, Warcom, Yawei,...

Our tool codes are listed according to the **tool angle**



STANDARD TANG

All dies R1 have base 60 mm 2.36", 90 mm 3.54" or 120 mm 4.72".

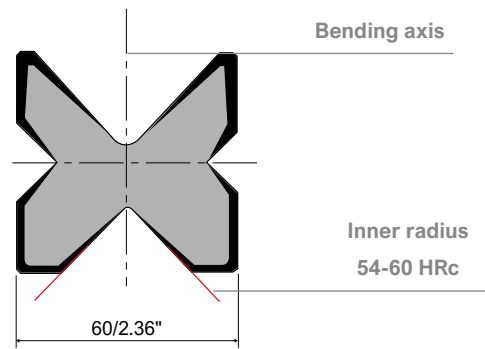
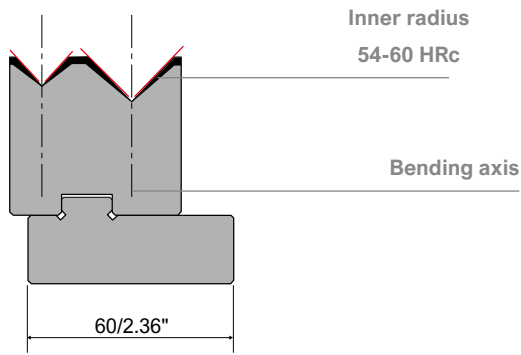
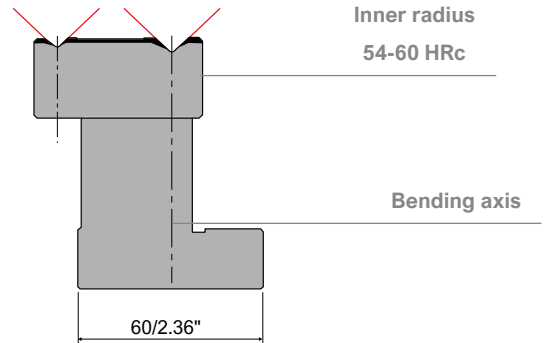
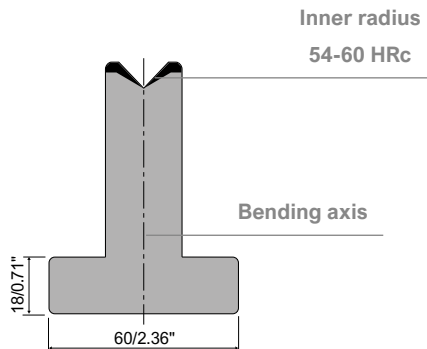

STANDARD LENGTH

	Serie TOP	Serie CLASSIC	Serie A	Serie CFH
525 mm 20.67"	●			
415 mm 16.34"		●	●	●
835 mm 32.87"		●	●	●
900 mm 35.43"		○	○	

○ available for some tool models only



Rolleri **BLACKFIRE** is a surface treatment against steel oxidation. This chemical treatment is a long-term solution against oxidation and rust.



Rolleri **FREEZINC** is a surface treatment to avoid metal residues of galvanized steel or aluminium from remaining on tools during bending. Tools are also protected from oxidation and you don't need to clean them anymore.

MODIFICATIONS WEDGE/BAR TAIL

To use R1 dies, a 10 mm 0.39" groove is milled where a ground bar is mounted.

Wedge/BarTail (W x H)		System
13 x 30 mm 0.51" x 1.18"	R2 R3	Bystronic-Beyeler, Safan, Trumpf,...
55 x 55 mm 2.16" x 2.16"	RX	EHT
12.7 x 29 mm 0.5" x 1.14"	R4	LVD
35 x 55 mm 1.37" x 2.16"	RX	Weinbrenner

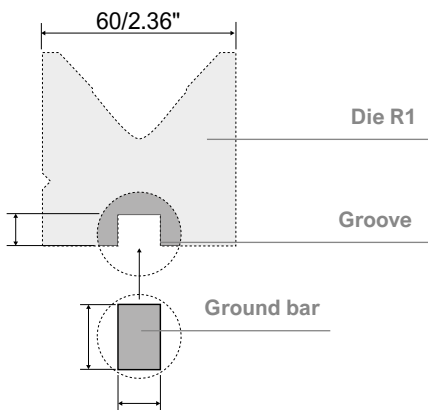

SEGMENTATION

Special segmentation is available on request - check the feasibility with sales@rolleri.it

FC: 495 mm - 19.48"
mm: 25-30-35-40-45-50-100-170
in: 0.98-1.18-1.37-1.57-1.77-1.97-3.94-9.84

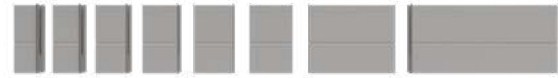

F: 805 mm - 31.69"
mm: 200-50-40-20-15-10-370-100
in: 7.87-1.97-1.57-0.78-0.59-0.39-14.56-3.94

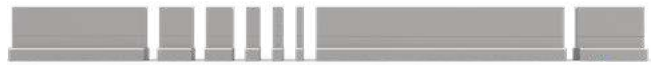

FX: 795 mm - 31.29"
mm: 100-250-20-25-30-35-40-45-50-200
in: 3.94-9.84-0.78-0.98-1.18-1.37-1.57-1.77-1.96-7.87



FC (A series): 835 mm - 32.87"
mm: 10-15-20-40-50-100-200-400
in: 0.39-0.59-0.78-1.57-1.96-3.94 -7.87-15.75



F: 800 mm - 21.49"
mm: 100-10-15-15-20-40-50-150-400
in: 3.94-0.39-0.59-0.59-0.79-1.57-1.97-5.90-15.74



Request our clamping, punching and ironworker, consumables laser, panel bending tools and shear blades catalogues on www.rolleritools.com/download



Create your account on www.rolleritools.com
You can use Rolleri website to check the delivery time, request quotes, stay update with the news, check prices and place orders directly.

M26.90.01

835 mm 32.87" 9.0 kg
 415 mm 16.34" 4.5 kg
 900 mm 35.43" 10.0 kg

90° >

C45: 560-710 N/mm²
 1000 kN/m max.

90°
 H=26 | R=0.4 | V=6 mm
 H=26 | R=0.6 | V=10 mm
 H=1.02 | R=0.016 | V=0.24 in
 H=1.02 | R=0.024 | V=0.39 in

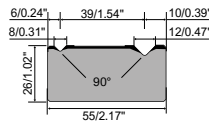

M26.90.02

835 mm 32.87" 9.0 kg
 415 mm 16.34" 4.5 kg
 900 mm 35.43" 10.0 kg

C45: 560-710 N/mm²
 1000 kN/m max.

90°
 H=26 | R=0.5 | V=8 mm
 H=26 | R=0.8 | V=12 mm
 H=1.02 | R=0.020 | V=0.31 in
 H=1.02 | R=0.031 | V=0.47 in

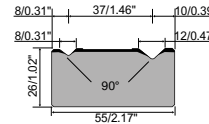

M26.90.03

835 mm 32.87" 9.0 kg
 415 mm 16.34" 4.5 kg

C45: 560-710 N/mm²
 1000 kN/m max.

90°
 H=26 | R=0.3 | V=4 mm
 H=26 | R=0.5 | V=7 mm
 H=1.02 | R=0.012 | V=0.16 in
 H=1.02 | R=0.020 | V=0.28 in

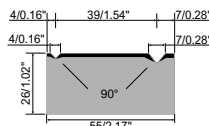

M26.88.01

835 mm 32.87" 9.0 kg
 415 mm 16.34" 4.5 kg

88° >

C45: 560-710 N/mm²
 1000 kN/m max.

88°
 H=26 | R=0.4 | V=6 mm
 H=26 | R=0.6 | V=10 mm
 H=1.02 | R=0.016 | V=0.24 in
 H=1.02 | R=0.024 | V=0.39 in

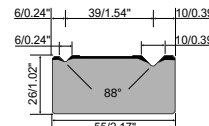

M26.88.02

835 mm 32.87" 9.0 kg
 415 mm 16.34" 4.5 kg

C45: 560-710 N/mm²
 1000 kN/m max.

88°
 H=26 | R=0.5 | V=8 mm
 H=26 | R=0.8 | V=12 mm
 H=1.02 | R=0.020 | V=0.31 in
 H=1.02 | R=0.031 | V=0.47 in

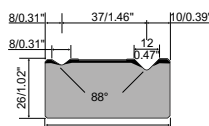

M26.88.03

835 mm 32.87" 9.0 kg
 415 mm 16.34" 4.5 kg

C45: 560-710 N/mm²
 1000 kN/m max.

88°
 H=26 | R=2.75 | V=12 mm
 H=26 | R=3 | V=20 mm
 H=1.02 | R=0.108 | V=0.47 in
 H=1.02 | R=0.118 | V=0.79 in

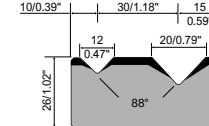

M26.88.04

835 mm 32.87" 8.0 kg
 415 mm 16.34" 4.0 kg

C45: 560-710 N/mm²
 1000 kN/m max.

88°
 H=26 | R=2.75 | V=16 mm
 H=26 | R=2.75 | V=25 mm
 H=1.02 | R=0.108 | V=0.63 in
 H=1.02 | R=0.108 | V=0.98 in

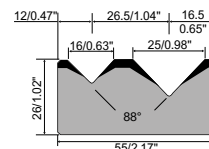

M26.88.05

835 mm 32.87" 8.0 kg
 415 mm 16.34" 4.0 kg

C45: 560-710 N/mm²
 1000 kN/m max.

88°
 H=26 | R=2.75 | V=14 mm
 H=26 | R=3 | V=18 mm
 H=1.02 | R=0.108 | V=0.55 in
 H=1.02 | R=0.118 | V=0.71 in

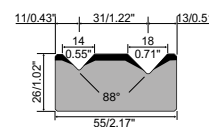

Create your account on www.rolleritools.com
 You can use Rolleri website to check the delivery time, request quotes, stay update with the news, check prices and place orders directly.



The Bending handbook target is to supply practice and useful information to reach quickly the required result. A lot of examples, easy formulas and information which explain the proper attitude towards the bending process.



M26.60.01



835 mm 32.87" 9.0 kg
415 mm 16.34" 4.5 kg
900 mm 35.43" 10.0 kg

60° >

C45: 560-710 N/mm²
600 kN/m max.

60°
H=26 | R=0.5 | V=6 mm
H=26 | R=0.8 | V=10 mm
H=1.02 | R=0.020 | V=0.24 in
H=1.02 | R=0.031 | V=0.39 in

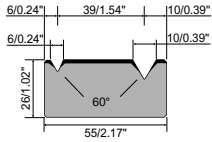

M26.60.02



835 mm 32.87" 9.0 kg
415 mm 16.34" 4.5 kg

C45: 560-710 N/mm²
800 kN/m max.

60°
H=26 | R=0.5 | V=8 mm
H=26 | R=0.8 | V=12 mm
H=1.02 | R=0.020 | V=0.31 in
H=1.02 | R=0.031 | V=0.47 in

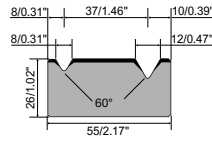

M26.60.03



835 mm 32.87" 8.0 kg
415 mm 16.34" 4.5 kg

C45: 560-710 N/mm²
800 kN/m max.

60°
H=26 | R=0.8 | V=12 mm
H=26 | R=3 | V=20 mm
H=1.02 | R=0.031 | V=0.24 in
H=1.02 | R=0.118 | V=0.39 in

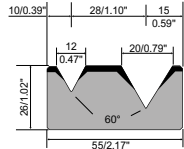

M26.60.05



835 mm 32.87" 8.0 kg
415 mm 16.34" 4.5 kg

C45: 560-710 N/mm²
800 kN/m max.

60°
H=26 | R=3 | V=16 mm
H=26 | R=3 | V=20 mm
H=1.02 | R=0.118 | V=0.63 in
H=1.02 | R=0.118 | V=0.79 in

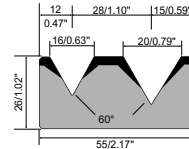

M31.35.01



835 mm 32.87" 11 kg
415 mm 16.34" 5.5 kg

35° >

C45: 560-710 N/mm²
300 kN/m max.

35°
H=31 | R=0.6 | V=6 mm
H=31 | R=1 | V=10 mm
H=1.22 | R=0.024 | V=0.24 in
H=1.22 | R=0.039 | V=0.39 in

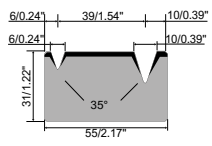

M31.35.02



835 mm 32.87" 10.0 kg
415 mm 16.34" 5.0 kg

C45: 560-710 N/mm²
300 kN/m max.

35°
H=31 | R=1 | V=8 mm
H=31 | R=1.2 | V=12 mm
H=1.22 | R=0.039 | V=0.31 in
H=1.2 | R=0.047 | V=0.47 in

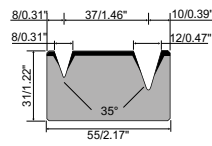

SU034



835 mm 32.87" 9.0 kg
415 mm 16.34" 4.5 kg

C45: 560-710 N/mm²

H=34 mm
H=1.34 in

Holder

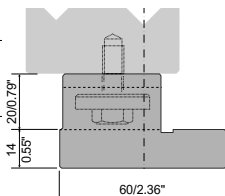

SU055



835 mm 32.87" 14.0 kg
415 mm 16.34" 7.2 kg

C45: 560-710 N/mm²

H=55 mm
H=2.17 in

Holder

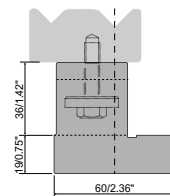

SU075



835 mm 32.87" 20.5 kg
415 mm 16.34" 10.0 kg

C45: 560-710 N/mm²

H=75 mm
H=2.95

Holder

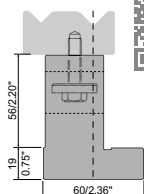



46-10

835 mm 32.87" 9.7 kg
 415 mm 16.34" 4.8.0 kg
 795 mm 31.29" 9.7 kg FX
 805 mm 31.69" 9.7 kg F

90° >



C45: 560-710 N/mm²
 800 kN/m max.

90°
 H=46 | R=0.3 | V=4 mm
 H=46 | R=0.5 | V=7 mm
 H=1.81 | R=0.012 | V=0.16 in
 H=1.81 | R=0.020 | V=0.28 in

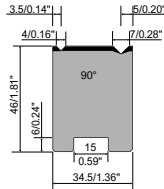

46-11

835 mm 32.87" 10.3 kg
 415 mm 16.34" 5.1 kg
 795 mm 31.29" 9.9 kg FX
 805 mm 31.69" 9.0 kg F



C45: 560-710 N/mm²
 800 kN/m max.

90°
 H=46 | R=0.4 | V=6 mm
 H=46 | R=0.6 | V=10 mm
 H=1.81 | R=0.016 | V=0.24 in
 H=1.81 | R=0.024 | V=0.39 in

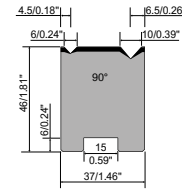

46-12

835 mm 32.87" 10.0 kg
 415 mm 16.34" 5.0 kg
 795 mm 31.29" 9.5 kg FX
 805 mm 31.69" 10.0 kg F



C45: 560-710 N/mm²
 800 kN/m max.

90°
 H=46 | R=0.5 | V=8 mm
 H=46 | R=0.8 | V=12 mm
 H=1.81 | R=0.020 | V=0.31 in
 H=1.81 | R=0.031 | V=0.47 in

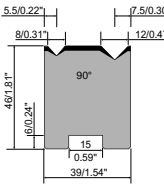

46.11.88

835 mm 32.87" 10.3 kg
 415 mm 16.34" 5.2 kg
 795 mm 31.29" 9.9 kg FX
 805 mm 31.69" 10.3 kg F



C45: 560-710 N/mm²
 800 kN/m max.

88°
 H=46 | R=0.4 | V=6 mm
 H=46 | R=0.6 | V=10 mm
 H=1.81 | R=0.016 | V=0.24 in
 H=1.81 | R=0.024 | V=0.39 in

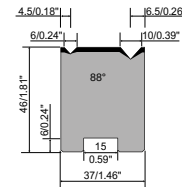

46.13

835 mm 32.87" 10.9 kg
 415 mm 16.34" 5.4 kg
 795 mm 31.29" 9.6 kg FX
 805 mm 31.69" 9.6 kg F



C45: 560-710 N/mm²
 800 kN/m max.

88°
 H=46 | R=0.5 | V=8 mm
 H=46 | R=0.8 | V=12 mm
 H=1.81 | R=0.020 | V=0.31 in
 H=1.81 | R=0.031 | V=0.47 in

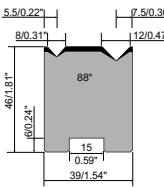

46.14

835 mm 32.87" 12 kg
 415 mm 16.34" 6 kg
 795 mm 31.29" 11.4 kg FX
 805 mm 31.69" 11.5 kg F



C45: 560-710 N/mm²
 800 kN/m max.

88°
 H=46 | R=0.8 | V=12 mm
 H=46 | R=1.75 | V=20 mm
 H=1.81 | R=0.031 | V=0.47 in
 H=1.81 | R=0.069 | V=0.79 in

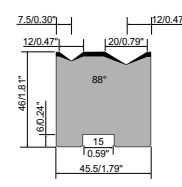

46.15

835 mm 32.87" 12.6 kg
 415 mm 16.34" 6 kg
 795 mm 31.29" 12 kg FX
 805 mm 31.69" 12.1 kg F



C45: 560-710 N/mm²
 800 kN/m max.

88°
 H=46 | R=1.25 | V=14 mm
 H=46 | R=1.5 | V=18 mm
 H=1.81 | R=0.049 | V=0.55 in
 H=1.81 | R=0.059 | V=0.71 in

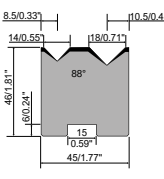

46.16

835 mm 32.87" 13 kg
 415 mm 16.34" 6.5 kg
 795 mm 31.29" 12.4 kg FX
 805 mm 31.69" 12.5 kg F



C45: 560-710 N/mm²
 800 kN/m max.

88°
 H=46 | R=1.5 | V=16 mm
 H=46 | R=1.75 | V=25 mm
 H=1.81 | R=0.059 | V=0.63 in
 H=1.81 | R=0.069 | V=0.98 in

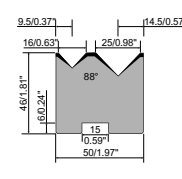

FX: 795 mm - 31.29"

mm: 100-250-20-25-30-35-40-45-50 -200

in: 3.94-9.84-0.78-0.98-1.18-1.37-1.57-1.77-1.96-7.87

F: 805 mm - 31.69"

mm: 200-50-40-20-15-10-370-100

In: 7.87-1.97-1.57-0.78-0.59-0.39-14.56-3.94





M26.85.02



835 mm 32.87" 9.0 kg
 415 mm 16.34" 4.5 kg
 795 mm 31.29" 8.6 kg FX
 805 mm 31.69" 8.7 kg F

85° >

42Cr: 900-1150 N/mm²
 1000 kN/m max.

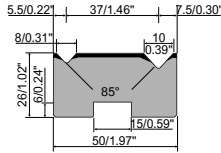

85°
 H=26 | R=0.5 | V=8 mm
 H=26 | R=0.8 | V=12 mm
 H=1.02 | R=0.020 | V=0.31 in
 H=1.02 | R=0.031 | V=0.47 in

PM50 + Support is needed

46.17



835 mm 32.87" 12.2 kg
 415 mm 16.34" 6 kg
 795 mm 31.29" 12.2 kg FX
 805 mm 31.69" 12.2 kg F

30° >

C45: 560-710 N/mm²
 1000 kN/m max.

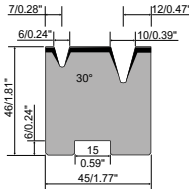

30°
 H=46 | R=0.6 | V=6 mm
 H=46 | R=1 | V=10 mm
 H=1.81 | R=0.024 | V=0.24 in
 H=1.81 | R=0.039 | V=0.39 in

46.18



835 mm 32.87" 13.2 kg
 415 mm 16.34" 6.6 kg
 795 mm 31.29" 13 kg FX
 805 mm 31.69" 13 kg F

C45: 560-710 N/mm²
 400 kN/m max.

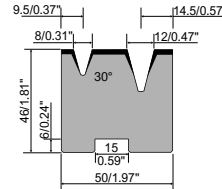

30°
 H=46 | R=0.8 | V=8 mm
 H=46 | R=1.5 | V=12 mm
 H=1.81 | R=0.031 | V=0.31 in
 H=1.81 | R=0.059 | V=0.47 in

PM50



835 mm 32.87" 4.0 kg
 415 mm 16.34" 3.7 kg

C45: 560-710 N/mm²
 1000 kN/m max.

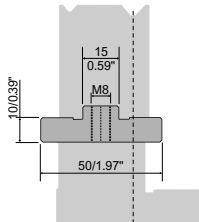

H=15 mm
 H=0.59 in

Holder

PM50.20



835 mm 32.87" 5.4 kg
 415 mm 16.34" 2.6 kg

C45: 560-710 N/mm²
 1000 kN/m max.

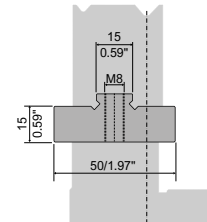

H=20 mm
 H=0.79 in

Holder

PM60



835 mm 32.87" 7.5 kg
 415 mm 16.34" 3.7 kg

C45: 560-710 N/mm²
 1000 kN/m max.

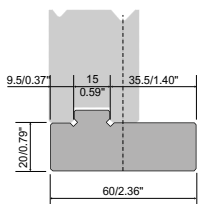

H=25 mm
 H=0.98 in

Holder

PB60



0.2 kg

Fe37: 370-470 N/mm²

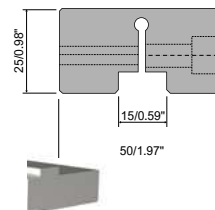

H=25 mm

H=0.98 in

Holder

FX: 795 mm - 31.29"

mm: 100-250-20-25-30-35-40-45-50 -200

in: 3.94-9.84-0.78-0.98-1.18-1.37-1.57-1.77-1.96-7.87

F: 805 mm - 31.69"

mm: 200-50-40-20-15-10-370-100

in: 7.87-1.97-1.57-0.78-0.59-0.39-14.56-3.94





AMR60.04.88

835 mm	32.87"	5.4 kg
415 mm	16.34"	2.7 kg
795 mm	31.29"	5.1 kg FX
805 mm	31.69"	5.2 kg F

88° >



C45: 560-710 N/mm²
1000 kN/m max.

88°
H=60 | R=0.6 | V=4 mm
H=2.36 | R=0.024 | V=4 in

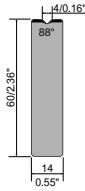

AMR60.06.88

835 mm	32.87"	5.4 kg
415 mm	16.34"	2.7 kg
795 mm	31.29"	5.2 kg FX
805 mm	31.69"	5.2 kg F



C45: 560-710 N/mm²
1000 kN/m max.

88°
H=60 | R=0.8 | V=6 mm
H=2.36 | R=0.031 | V=0.24 in

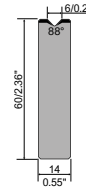

AMR60.08.88

835 mm	32.87"	5.4 kg
415 mm	16.34"	2.7 kg
795 mm	31.29"	5.2 kg FX
805 mm	31.69"	5.2 kg F



C45: 560-710 N/mm²
1000 kN/m max.

88°
H=60 | R=1.0 | V=8 mm
H=2.36 | R=0.039 | V=0.31 in

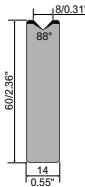

AMR60.10.88

835 mm	32.87"	5.6 kg
415 mm	16.34"	2.8 kg
795 mm	31.29"	5.4 kg FX
805 mm	31.69"	5.4 kg F



C45: 560-710 N/mm²
1000 kN/m max.

88°
H=60 | R=1.2 | V=10 mm
H=2.36 | R=0.047 | V=0.39 in

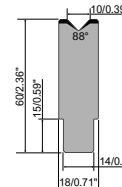

AMR60.12.88

835 mm	32.87"	6.1 kg
415 mm	16.34"	3 kg
795 mm	31.29"	5.8 kg FX
805 mm	31.69"	5.9 kg F



C45: 560-710 N/mm²
1000 kN/m max.

88°
H=60 | R=1.5 | V=12 mm
H=2.36 | R=0.059 | V=0.47 in

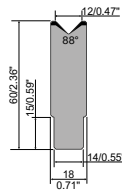

AMR60.16.88

835 mm	32.87"	7.1 kg
415 mm	16.34"	3.5 kg
795 mm	31.29"	6.8 kg FX
805 mm	31.69"	6.9 kg F



C45: 560-710 N/mm²
1000 kN/m max.

88°
H=60 | R=2 | V=16 mm
H=2.36 | R=0.079 | V=0.63 in

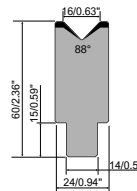

AMR60.20.88

835 mm	32.87"	8.0 kg
415 mm	16.34"	4.0 kg
795 mm	31.29"	7.8 kg FX
805 mm	31.69"	7.8 kg F



C45: 560-710 N/mm²
1000 kN/m max.

88°
H=60 | R=2 | V=20 mm
H=2.36 | R=0.079 | V=0.79 in

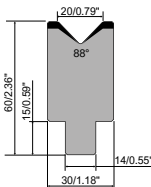

AMR60.25.88

835 mm	32.87"	9.1 kg
415 mm	16.34"	4.6 kg
795 mm	31.29"	8.9 kg FX
805 mm	31.69"	8.9 kg F



C45: 560-710 N/mm²
1000 kN/m max.

88°
H=60 | R=3 | V=25 mm
H=2.36 | R=0.118 | V=0.98 in

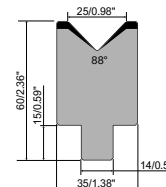

FX: 795 mm - 31.29"

mm: 100-250-20-25-30-35-40-45-50 -200

in: 3.94-9.84-0.78-0.98-1.18-1.37-1.57-1.77-1.96-7.87

F: 805 mm - 31.69"

mm: 200-50-40-20-15-10-370-100

in: 7.87-1.97-1.57-0.78-0.59-0.39-14.56-3.94





AMR60.04.85

835 mm 32.87" 5.4 kg
 415 mm 16.34" 2.7 kg
 795 mm 31.29" 5.2 kg FX
 805 mm 31.69" 5.2 kg F

85° >



C45: 560-710 N/mm²
 1000 kN/m max.

85°

H=60 | R=0.6 | V=4 mm

H=2.36 | R=0.024 | V=0.114 in

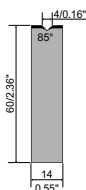

AMR60.06.85

835 mm 32.87" 5.4 kg
 415 mm 16.34" 2.7 kg
 795 mm 31.29" 5.1 kg FX
 805 mm 31.69" 5.2 kg F



C45: 560-710 N/mm²
 1000 kN/m max.

85°

H=60 | R=0.8 | V=6 mm

H=2.36 | R=0.031 | V=0.24 in

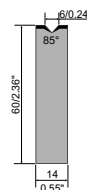

AMR60.08.85

835 mm 32.87" 5.4 kg
 415 mm 16.34" 2.7 kg
 795 mm 31.29" 5.1 kg FX
 805 mm 31.69" 5.2 kg F



C45: 560-710 N/mm²
 1000 kN/m max.

85°

H=60 | R=1 | V=8 mm

H=2.36 | R=0.39 | V=0.31 in

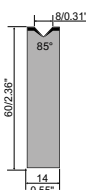

AMR60.10.85

835 mm 32.87" 5.6 kg
 415 mm 16.34" 2.8 kg
 795 mm 31.29" 5.3 kg FX
 805 mm 31.69" 5.4 kg F



C45: 560-710 N/mm²
 1000 kN/m max.

85°

H=60 | R=1.2 | V=10 mm

H=2.36 | R=0.047 | V=0.39 in

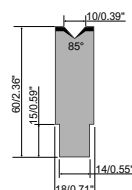

AMR60.12.85

835 mm 32.87" 6.1 kg
 415 mm 16.34" 3.0 kg
 795 mm 31.29" 5.8 kg FX
 805 mm 31.69" 5.9 kg F



C45: 560-710 N/mm²
 1000 kN/m max.

85°

H=60 | R=1.5 | V=12 mm

H=2.36 | R=0.059 | V=0.47 in

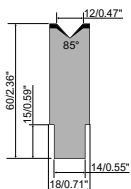

AMR60.16.85

835 mm 32.87" 7.1 kg
 415 mm 16.34" 3.5 kg
 795 mm 31.29" 6.8 kg FX
 805 mm 31.69" 6.9 kg F



C45: 560-710 N/mm²
 1000 kN/m max.

85°

H=60 | R=2 | V=16 mm

H=2.36 | R=0.079 | V=0.63 in

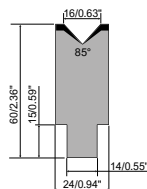

AMR60.20.85

835 mm 32.87" 8.0 kg
 415 mm 16.34" 4.0 kg
 795 mm 31.29" 7.6 kg FX
 805 mm 31.69" 7.7 kg F



C45: 560-710 N/mm²
 1000 kN/m max.

85°

H=60 | R=2 | V=20 mm

H=2.36 | R=0.079 | V=0.79 in

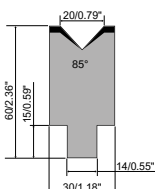

AMR60.25.85

835 mm 32.87" 9.2 kg
 415 mm 16.34" 4.6 kg
 795 mm 31.29" 8.8 kg FX
 805 mm 31.69" 8.9 kg F



C45: 560-710 N/mm²
 1000 kN/m max.

85°

H=60 | R=3 | V=25 mm

H=2.36 | R=0.118 | V=0.98 in

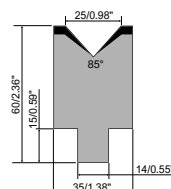

FX: 795 mm - 31.29"

mm: 100-250-20-25-30-35-40-45-50 -200

in: 3.94-9.84-0.78-0.98-1.18-1.37-1.57-1.77-1.96-7.87

F: 805 mm - 31.69"

mm: 200-50-40-20-15-10-370-100

in: 7.87-1.97-1.57-0.78-0.59-0.39-14.56-3.94





AMR60.06.30

835 mm	32.87"	5.9 kg
415 mm	16.34"	2.9 kg
795 mm	31.29"	5.6 kg FX
805 mm	31.69"	5.7 kg F

30° >



C45: 560-710 N/mm²
1000 kN/m max.

30°
H=60 | R=0.6 | V=6 mm
H=2.36 | R=0.024 | V=0.24 in

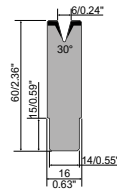

AMR60.08.30

835 mm	32.87"	6.6 kg
415 mm	16.34"	3.3 kg
795 mm	31.29"	6.3 kg FX
805 mm	31.69"	6.4 kg F



C45: 560-710 N/mm²
1000 kN/m max.

30°
H=60 | R=0.8 | V=8 mm
H=2.36 | R=0.031 | V=0.31 in

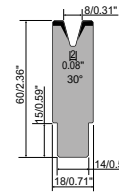

AMR60.10.30

835 mm	32.87"	7.8 kg
415 mm	16.34"	3.9 kg
795 mm	31.29"	7.4 kg FX
805 mm	31.69"	7.5 kg F



C45: 560-710 N/mm²
1000 kN/m max.

30°
H=60 | R=1 | V=10 mm
H=2.36 | R=0.039 | V=0.39 in

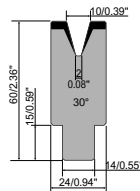

AMR60.12.30

835 mm	32.87"	7.8 kg
415 mm	16.34"	3.9 kg
795 mm	31.29"	7.5 kg FX
805 mm	31.69"	7.6 kg F



C45: 560-710 N/mm²
1000 kN/m max.

30°
H=60 | R=1.5 | V=12 mm
H=2.36 | R=0.059 | V=0.47 in

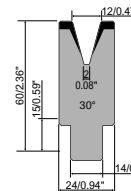

AMR60.16.30

835 mm	32.87"	8.8 kg
415 mm	16.34"	4.7 kg
795 mm	31.29"	8.4 kg FX
805 mm	31.69"	9.2 kg F



C45: 560-710 N/mm²
1000 kN/m max.

30°
H=60 | R=2 | V=16 mm
H=2.36 | R=0.079 | V=0.63 in

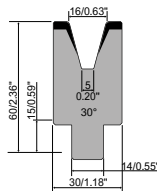

AMR60.20.30

835 mm	32.87"	15.9 kg
415 mm	16.34"	7.9 kg
795 mm	31.29"	15.3 kg FX
805 mm	31.69"	15.3 kg F



C45: 560-710 N/mm²
1000 kN/m max.

30°
H=60 | R=2.5 | V=20 mm
H=2.36 | R=0.098 | V=0.79 in

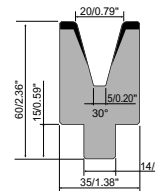

AMR65.25.30

835 mm	32.87"	13.0 kg
415 mm	16.34"	6.4 kg
795 mm	31.29"	12.4 kg FX
805 mm	31.69"	12.2 kg F



C45: 560-710 N/mm²
1000 kN/m max.

30°
H=60 | R=3 | V=25 mm
H=2.36 | R=0.118 | V=0.98 in

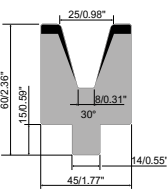

FX: 795 mm - 31.29"

mm: 100-250-20-25-30-35-40-45-50 -200

in: 3.94-9.84-0.78-0.98-1.18-1.37-1.57-1.77-1.96-7.87

F: 805 mm - 31.69"

mm: 200-50-40-20-15-10-370-100

In: 7.87-1.97-1.57-0.78-0.59-0.39-14.56-3.94





SU61F

835 mm 32.87" 16.0 kg
415 mm 16.34" 7.3 kg



C45: 560-710 N/mm²
1000 kN/m max.

H=61.5 mm
H=2.42 in

Holder

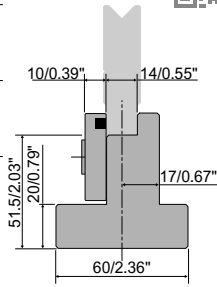

08000

1050 mm 41.34" 14.0 kg



C45: 560-710 N/mm²
950 kN/m max.

H=61.5 mm
H=2.42 in

Holder

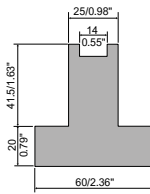

08100

1260 mm 49.61" 14.0 kg



C45: 560-710 N/mm²
950 kN/m max.

H=61.5 mm
H=2.42 in

Holder

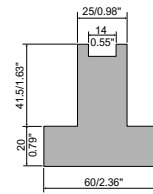

T dies CLASSIC serie

T80.06.90

835 mm 32.87" 13.0 kg
415 mm 16.34" 6.5 kg
795 mm 31.29" 12.4 kg FX
805 mm 31.69" 12.5 kg F
900 mm 35.43" 14.0 kg



90° >

C45: 560-710 N/mm²
1000 kN/m max.

90°

H=80 | R=0.4 | V=6 mm
H=3.15 | R=0.01 | V=0.24 in

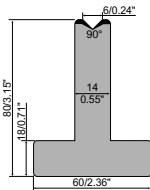

T80.08.90

835 mm 32.87" 13.0 kg
415 mm 16.34" 6.5 kg
795 mm 31.29" 12.4 kg FX
805 mm 31.69" 12.5 kg F
900 mm 35.43" 14.0 kg



C45: 560-710 N/mm²
1000 kN/m max.

90°

H=80 | R=0.5 | V=8 mm
H=3.15 | R=0.02 | V=0.31 in

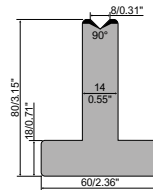

T80.10.90

835 mm 32.87" 14.2 kg
415 mm 16.34" 7.1 kg
795 mm 31.29" 13.5 kg FX
805 mm 31.69" 13.7 kg F



C45: 560-710 N/mm²
1000 kN/m max.

90°

H=80 | R=0.6 | V=10 mm
H=3.15 | R=0.02 | V=0.39 in

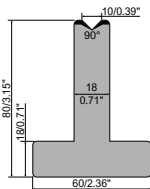

T80.12.90

835 mm 32.87" 14.0 kg
415 mm 16.34" 7.0 kg
795 mm 31.29" 13.3 kg FX
805 mm 31.69" 13.5 kg F



C45: 560-710 N/mm²
1000 kN/m max.

90°

H=80 | R=0.8 | V=12 mm
H=3.15 | R=0.03 | V=0.47 in

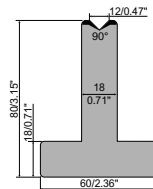

FX: 795 mm - 31.29"

mm: 100-250-20-25-30-35-40-45-50 -200

in: 3.94-9.84-0.78-0.98-1.18-1.37-1.57-1.77-1.96-7.87

F: 805 mm - 31.69"

mm: 200-50-40-20-15-10-370-100

in: 7.87-1.97-1.57-0.78-0.59-0.39-14.56-3.94



T120.06.90

835 mm 32.87" 16.5 kg
 415 mm 16.34" 8.2 kg
 795 mm 31.29" 15.7 kg FX
 805 mm 31.69" 15.9 kg F

C45: 560-710 N/mm²
 1000 kN/m max.

90°
 H=120 | R=0.4 | V=6 mm
 H=4.72 | R=0.01 | V=0.24 in

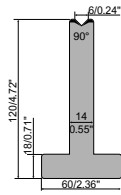

T120.08.90

835 mm 32.87" 16.5 kg
 415 mm 16.34" 8.2 kg
 795 mm 31.29" 15.9 kg FX
 805 mm 31.69" 15.7 kg F

C45: 560-710 N/mm²
 1000 kN/m max.

90°
 H=120 | R=0.5 | V=8 mm
 H=4.72 | R=0.02 | V=0.31 in

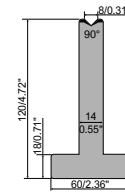

T120.10.90

835 mm 32.87" 19.0 kg
 415 mm 16.34" 9.4 kg
 795 mm 31.29" 18.1 kg FX
 805 mm 31.69" 18.3 kg F

C45: 560-710 N/mm²
 1000 kN/m max.

90°
 H=120 | R=0.6 | V=10 mm
 H=4.72 | R=0.02 | V=0.39 in

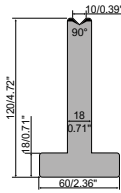

T120.12.90

835 mm 32.87" 18.9 kg
 415 mm 16.34" 9.4 kg
 795 mm 31.29" 18.0 kg FX
 805 mm 31.69" 18.2 kg F

C45: 560-710 N/mm²
 1000 kN/m max.

90°
 H=120 | R=0.8 | V=12 mm
 H=4.72 | R=0.03 | V=0.47 in

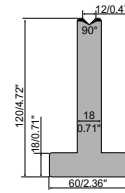

T80.06.88

835 mm 32.87" 13.0 kg
 415 mm 16.34" 6.5 kg
 795 mm 31.29" 12.4 kg FX
 805 mm 31.69" 12.5 kg F

C45: 560-710 N/mm²
 1000 kN/m max.

88°
 H=80 | R=0.4 | V=6 mm
 H=3.15 | R=0.01 | V=0.24 in

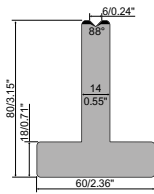

88° >



TR80.06.88

835 mm 32.87" 13.0 kg
 415 mm 16.34" 6.5 kg
 795 mm 31.29" 12.4 kg FX
 805 mm 31.69" 12.5 kg F

C45: 560-710 N/mm²
 1000 kN/m max.

88°
 H=80 | R=2.75 | V=6 mm
 H=3.15 | R=0.11 | V=0.24 in

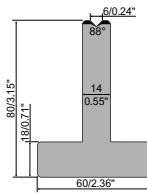

T80.08.88

835 mm 32.87" 13.0 kg
 415 mm 16.34" 6.5 kg
 795 mm 31.29" 12.4 kg FX
 805 mm 31.69" 12.5 kg F

C45: 560-710 N/mm²
 1000 kN/m max.

88°
 H=80 | R=0.5 | V=8 mm
 H=3.15 | R=0.02 | V=0.31 in

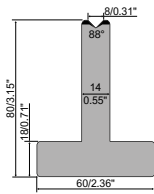

TR80.08.88

835 mm 32.87" 13.0 kg
 415 mm 16.34" 6.5 kg
 795 mm 31.29" 12.4 kg FX
 805 mm 31.69" 12.5 kg F

C45: 560-710 N/mm²
 1000 kN/m max.

88°
 H=80 | R=2.75 | V=8 mm
 H=3.15 | R=0.11 | V=0.31 in

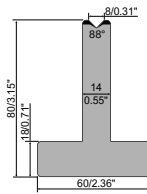

FX: 795 mm - 31.29"

mm: 100-250-20-25-30-35-40-45-50 -200

in: 3.94-9.84-0.78-0.98-1.18-1.37-1.57-1.77-1.96-7.87

F: 805 mm - 31.69"

mm: 200-50-40-20-15-10-370-100

In: 7.87-1.97-1.57-0.78-0.59-0.39-14.56-3.94



T80.10.88

835 mm 32.87" 14.2 kg
 415 mm 16.34" 7.1 kg
 795 mm 31.29" 13.5 kg FX
 805 mm 31.69" 13.7 kg F

C45: 560-710 N/mm²
 1000 kN/m max.

88°
 H=80 | R=0.8 | V=10 mm
 H=3.15 | R=0.03 | V=0.39 in

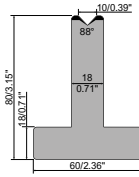

TR80.10.88

835 mm 32.87" 15 kg
 415 mm 16.34" 7.5 kg
 795 mm 31.29" 15 kg FX
 805 mm 31.69" 15 kg F

C45: 560-710 N/mm²
 1000 kN/m max.

88°
 H=80 | R=2.75 | V=10 mm
 H=3.15 | R=0.11 | V=0.39 in

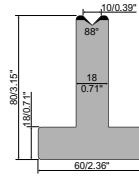

T80.12.88

835 mm 32.87" 14.0 kg
 415 mm 16.34" 7.0 kg
 795 mm 31.29" 13.3 kg FX
 805 mm 31.69" 13.5 kg F

C45: 560-710 N/mm²
 1000 kN/m max.

88°
 H=80 | R=2.75 | V=12 mm
 H=3.15 | R=0.108 | V=0.47 in

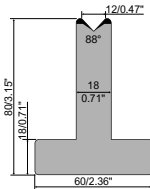

T80.16.88

835 mm 32.87" 16.6 kg
 415 mm 16.34" 8.3 kg
 795 mm 31.29" 15.8 kg FX
 805 mm 31.69" 16.0 kg F

C45: 560-710 N/mm²
 1000 kN/m max.

88°
 H=80 | R=2.75 | V=16 mm
 H=3.15 | R=0.108 | V=0.63 in

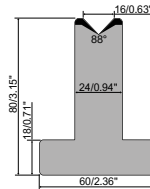

T80.20.88

835 mm 32.87" 18.5 kg
 415 mm 16.34" 9.2 kg
 795 mm 31.29" 17.6 kg FX
 805 mm 31.69" 17.8 kg F

C45: 560-710 N/mm²
 1000 kN/m max.

88°
 H=80 | R=3 | V=20 mm
 H=3.15 | R=0.118 | V=0.78 in

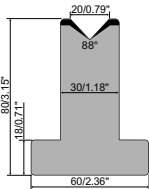

T80.25.88

835 mm 32.87" 20.2 kg
 415 mm 16.34" 10.0 kg
 795 mm 31.29" 19.2 kg FX
 805 mm 31.69" 19.5 kg F

C45: 560-710 N/mm²
 1000 kN/m max.

88°
 H=80 | R=3 | V=25 mm
 H=3.15 | R=0.118 | V=0.98 in

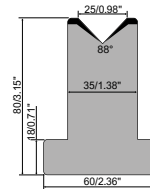

T120.06.88

835 mm 32.87" 16.5 kg
 415 mm 16.34" 8.2 kg
 795 mm 31.29" 15.2 kg FX
 805 mm 31.69" 15.9 kg F

C45: 560-710 N/mm²
 1000 kN/m max.

88°
 H=120 | R=0.4 | V=6 mm
 H=4.72 | R=0.01 | V=0.24 in

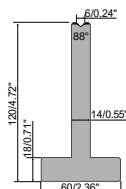

TR120.06.88

835 mm 32.87" 16 kg
 415 mm 16.34" 8.0 kg
 795 mm 31.29" 15.2 kg FX
 805 mm 31.69" 16 kg F

C45: 560-710 N/mm²
 1000 kN/m max.

88°
 H=120 | R=2.75 | V=6 mm
 H=4.72 | R=0.11 | V=0.24 in

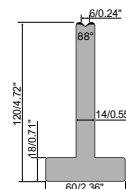

Bent sheet metal often shows two lines in the contact area with die. This is the consequence of friction between sheet metal and too small die radius. To avoid such bending marks you can use TR dies with bigger radius (we can also modify your dies) with [ROLFILM](#)



Click on the QR Code or scan it to watch the video and discover more about TR dies.

T120.08.88

835 mm	32.87"	16.5 kg
415 mm	16.34"	8.2 kg
795 mm	31.29"	15.7 kg FX
805 mm	31.69"	15.9 kg F

C45: 560-710 N/mm²
1000 kN/m max.

88°
H=120 | R=0.5 | V=8 mm
H=4.72 | R=0.02 | V=0.31 in

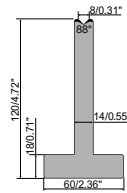

TR120.08.88

835 mm	32.87"	16 kg
415 mm	16.34"	8.0 kg
795 mm	31.29"	15.2 kg FX
805 mm	31.69"	16 kg F

C45: 560-710 N/mm²
1000 kN/m max.

88°
H=120 | R=2.75 | V=8 mm
H=4.72 | R=0.11 | V=0.31 in

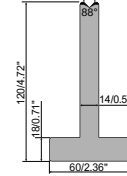
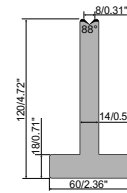

T120.10.88

835 mm	32.87"	19.0 kg
415 mm	16.34"	9.4 kg
795 mm	31.29"	18.1 kg FX
805 mm	31.69"	18.3 kg F

C45: 560-710 N/mm²
1000 kN/m max.

88°
H=120 | R=0.8 | V=10 mm
H=4.72 | R=0.03 | V=0.39 in

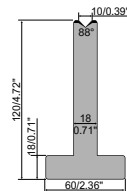

TR120.10.88

835 mm	32.87"	18.0 kg
415 mm	16.34"	9.0 kg
795 mm	31.29"	18.0 kg FX
805 mm	31.69"	18.0 kg F

C45: 560-710 N/mm²
1000 kN/m max.

88°
H=120 | R=2.75 | V=10 mm
H=4.72 | R=0.11 | V=0.39 in

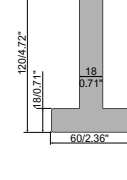
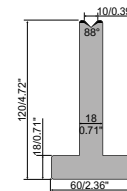

T120.12.88

835 mm	32.87"	18.9 kg
415 mm	16.34"	9.4 kg
795 mm	31.29"	18.0 kg FX
805 mm	31.69"	18.2 kg F

C45: 560-710 N/mm²
1000 kN/m max.

88°
H=120 | R=2.75 | V=12 mm
H=4.72 | R=0.11 | V=0.47 in

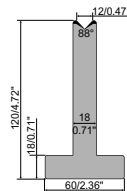

T120.16.88

835 mm	32.87"	22.0 kg
415 mm	16.34"	10.9 kg
795 mm	31.29"	20.9 kg FX
805 mm	31.69"	21.2 kg F

C45: 560-710 N/mm²
1000 kN/m max.

88°
H=120 | R=2.75 | V=16 mm
H=4.72 | R=0.11 | V=0.63 in

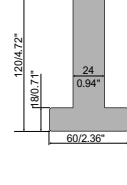
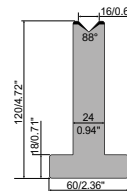

T120.20.88

835 mm	32.87"	27.0 kg
415 mm	16.34"	13.4 kg
795 mm	31.29"	25.7 kg FX
805 mm	31.69"	26.0 kg F

C45: 560-710 N/mm²
1000 kN/m max.

88°
H=120 | R=3 | V=20 mm
H=4.72 | R=0.118 | V=0.79 in

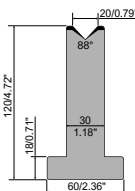

T120.25.88

835 mm	32.87"	30.0 kg
415 mm	16.34"	14.9 kg
795 mm	31.29"	28.6 kg FX
805 mm	31.69"	28.9 kg F

C45: 560-710 N/mm²
1000 kN/m max.

88°
H=120 | R=3 | V=25 mm
H=4.72 | R=0.118 | V=0.98 in

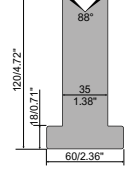
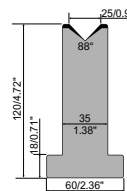

Bent sheet metal often shows two lines in the contact area with die. This is the consequence of friction between sheet metal and too small die radius. To avoid such bending marks you can use TR dies with bigger radius (we can also modify your dies) with [ROLFILM](#)



Click on the QR Code or scan it to watch the video and discover more about TR dies.



T80.06.85



835 mm 32.87" 13.0 kg
 415 mm 16.34" 6.5 kg
 795 mm 31.29" 12.4 kg FX
 805 mm 31.69" 12.5 kg F

85° >

C45: 560-710 N/mm²
 1000 kN/m max.

85°
 H=80 | R=2.75 | V=6 mm
 H=3.15 | R=0.108 | V=0.24 in

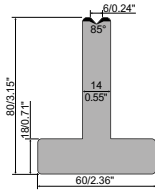

T80.08.85



835 mm 32.87" 13.0 kg
 415 mm 16.34" 6.5 kg
 795 mm 31.29" 12.4 kg FX
 805 mm 31.69" 12.5 kg F

C45: 560-710 N/mm²
 1000 kN/m max.

85°
 H=80 | R=2.75 | V=8 mm
 H=3.15 | R=0.108 | V=0.31 in

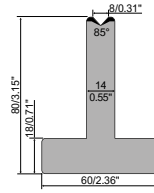

T80.10.85



835 mm 32.87" 14.2 kg
 415 mm 16.34" 7.1 kg
 795 mm 31.29" 13.5 kg FX
 805 mm 31.69" 13.7 kg F

C45: 560-710 N/mm²
 1000 kN/m max.

85°
 H=80 | R=2.75 | V=10 mm
 H=3.15 | R=0.108 | V=0.39 in

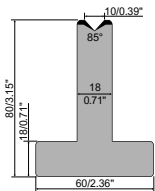

T80.12.85



835 mm 32.87" 14.0 kg
 415 mm 16.34" 7 kg
 795 mm 31.29" 13.3 kg FX
 805 mm 31.69" 13.5 kg F

C45: 560-710 N/mm²
 1000 kN/m max.

85°
 H=80 | R=2.75 | V=12 mm
 H=3.15 | R=0.108 | V=0.47 in

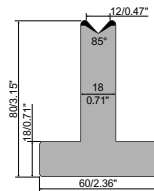

T80.16.85



835 mm 32.87" 16.6 kg
 415 mm 16.34" 8.3 kg
 795 mm 31.29" 15.8 kg FX
 805 mm 31.69" 16.0 kg F

C45: 560-710 N/mm²
 1000 kN/m max.

85°
 H=80 | R=2.75 | V=16 mm
 H=3.15 | R=0.108 | V=0.63 in

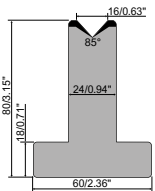

T80.20.85



835 mm 32.87" 18.5 kg
 415 mm 16.34" 9.2 kg
 795 mm 31.29" 17.6 kg FX
 805 mm 31.69" 17.8 kg F

C45: 560-710 N/mm²
 1000 kN/m max.

85°
 H=80 | R=3 | V=20 mm
 H=3.15 | R=0.118 | V=0.78 in

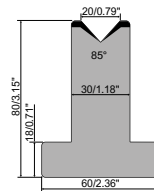

T80.25.85



835 mm 32.87" 20.2 kg
 415 mm 16.34" 10.0 kg
 795 mm 31.29" 19.2 kg FX
 805 mm 31.69" 19.5 kg F

C45: 560-710 N/mm²
 1000 kN/m max.

85°
 H=80 | R=3 | V=25 mm
 H=3.15 | R=0.118 | V=0.98 in

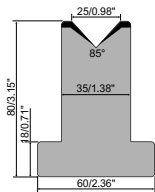

FX: 795 mm - 31.29"

mm: 100-250-20-25-30-35-40-45-50 -200

in: 3.94-9.84-0.78-0.98-1.18-1.37-1.57-1.77-1.96-7.87

F: 805 mm - 31.69"

mm: 200-50-40-20-15-10-370-100

in: 7.87-1.97-1.57-0.78-0.59-0.39-14.56-3.94



T120.06.85

835 mm 32.87" 16.3 kg
 415 mm 16.34" 8.1 kg
 795 mm 31.29" 15.7 kg FX
 805 mm 31.69" 15.7 kg F

C45: 560-710 N/mm²
 1000 kN/m max.

85°
 H=120 | R=2.75 | V=6 mm
 H=4.72 | R=0.108 | V=0.24 in

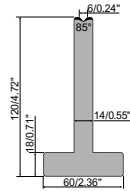

T120.08.85

835 mm 32.87" 16.3 kg
 415 mm 16.34" 8.1 kg
 795 mm 31.29" 15.7 kg FX
 805 mm 31.69" 15.7 kg F

C45: 560-710 N/mm²
 1000 kN/m max.

85°
 H=120 | R=2.75 | V=8 mm
 H=4.72 | R=0.108 | V=0.31 in

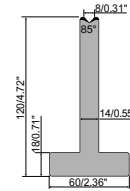

T120.10.85

835 mm 32.87" 19.0 kg
 415 mm 16.34" 9.5.0 kg
 795 mm 31.29" 19.0 kg FX
 805 mm 31.69" 19.0 kg F

C45: 560-710 N/mm²
 1000 kN/m max.

85°
 H=120 | R=2.75 | V=10 mm
 H=4.72 | R=0.108 | V=0.39 in

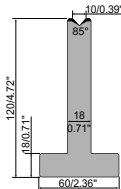

T120.12.85

835 mm 32.87" 18.9 kg
 415 mm 16.34" 9.4.0 kg
 795 mm 31.29" 18.2 kg FX
 805 mm 31.69" 18.2 kg F

C45: 560-710 N/mm²
 1000 kN/m max.

85°
 H=120 | R=2.75 | V=12 mm
 H=4.72 | R=0.108 | V=0.47 in

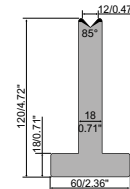

T120.16.85

835 mm 32.87" 22.7 kg
 415 mm 16.34" 11.3 kg
 795 mm 31.29" 21.9 kg FX
 805 mm 31.69" 21.9 kg F

C45: 560-710 N/mm²
 1000 kN/m max.

85°
 H=120 | R=2.75 | V=16 mm
 H=4.72 | R=0.108 | V=0.63 in

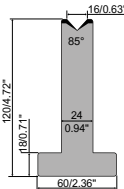

T120.20.85

835 mm 32.87" 26.4 kg
 415 mm 16.34" 13 kg
 795 mm 31.29" 25.5 kg FX
 805 mm 31.69" 25.5 kg F

C45: 560-710 N/mm²
 1000 kN/m max.

85°
 H=120 | R=3 | V=20 mm
 H=4.72 | R=0.118 | V=0.79 in

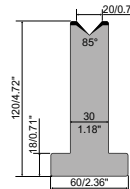

T120.25.85

835 mm 32.87" 30 kg
 415 mm 16.34" 15 kg
 795 mm 31.29" 30 kg FX
 805 mm 31.69" 30 kg F

C45: 560-710 N/mm²
 1000 kN/m max.

85°
 H=120 | R=3 | V=25 mm
 H=4.72 | R=0.118 | V=0.98 in

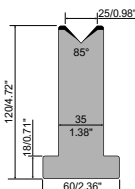

FX: 795 mm - 31.29"

mm: 100-250-20-25-30-35-40-45-50 -200

in: 3.94-9.84-0.78-0.98-1.18-1.37-1.57-1.77-1.96-7.87

F: 805 mm - 31.69"

mm: 200-50-40-20-15-10-370-100

In: 7.87-1.97-1.57-0.78-0.59-0.39-14.56-3.94





T80.06.80



835 mm 32.87" 13.0 kg
 415 mm 16.34" 6.5 kg
 795 mm 31.29" 12.4 kg FX
 805 mm 31.69" 12.5 kg F

80° >

C45: 560-710 N/mm²
 950 kN/m max.

80°
 H=80 | R=2.75 | V=6 mm
 H=3.15 | R=0.108 | V=0.24 in

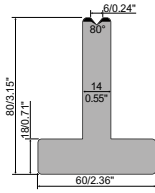

T80.08.80



835 mm 32.87" 13.0 kg
 415 mm 16.34" 6.5 kg
 795 mm 31.29" 12.4 kg FX
 805 mm 31.69" 12.5 kg F

C45: 560-710 N/mm²
 950 kN/m max.

80°
 H=80 | R=2.75 | V=8 mm
 H=3.15 | R=0.108 | V=0.31 in

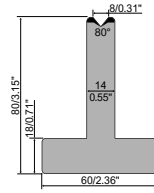

T80.10.80



835 mm 32.87" 14.2 kg
 415 mm 16.34" 7.1 kg
 795 mm 31.29" 13.5 kg FX
 805 mm 31.69" 13.7 kg F

C45: 560-710 N/mm²
 950 kN/m max.

80°
 H=80 | R=2.75 | V=10 mm
 H=3.15 | R=0.108 | V=0.39 in

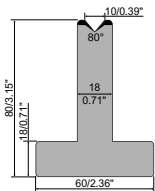

T80.12.80



835 mm 32.87" 14.0 kg
 415 mm 16.34" 7.0 kg
 795 mm 31.29" 13.3 kg FX
 805 mm 31.69" 13.5 kg F

C45: 560-710 N/mm²
 950 kN/m max.

80°
 H=80 | R=2.75 | V=12 mm
 H=3.15 | R=0.108 | V=0.47 in

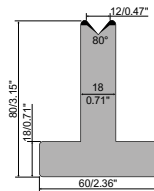

T80.16.80



835 mm 32.87" 16.6 kg
 415 mm 16.34" 8.3 kg
 795 mm 31.29" 15.8 kg FX
 805 mm 31.69" 16.0 kg F

C45: 560-710 N/mm²
 950 kN/m max.

80°
 H=80 | R=2.75 | V=16 mm
 H=3.15 | R=0.108 | V=0.63 in

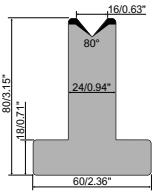

T80.20.80



835 mm 32.87" 18.5 kg
 415 mm 16.34" 9.2 kg
 795 mm 31.29" 17.6 kg FX
 805 mm 31.69" 17.8 kg F

C45: 560-710 N/mm²
 950 kN/m max.

80°
 H=80 | R=3 | V=25 mm
 H=3.15 | R=0.118 | V=0.98 in

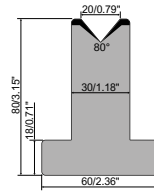

T80.25.80



835 mm 32.87" 20.2 kg
 415 mm 16.34" 10.0 kg
 795 mm 31.29" 19.2 kg FX
 805 mm 31.69" 19.5 kg F

C45: 560-710 N/mm²
 1000 kN/m max.

80°
 H=80 | R=3 | V=25 mm
 H=3.15 | R=0.118 | V=0.98 in

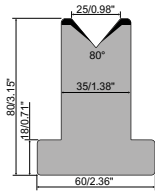

FX: 795 mm - 31.29"

mm: 100-250-20-25-30-35-40-45-50 -200

in: 3.94-9.84-0.78-0.98-1.18-1.37-1.57-1.77-1.96-7.87

F: 805 mm - 31.69"

mm: 200-50-40-20-15-10-370-100

in: 7.87-1.97-1.57-0.78-0.59-0.39-14.56-3.94



T120.06.80

835 mm 32.87" 16.5 kg
 415 mm 16.34" 8.2 kg
 795 mm 31.29" 15.7 kg FX
 805 mm 31.69" 15.9 kg F

C45: 560-710 N/mm²
 950 kN/m max.

80°
 H=120 | R=2.75 | V=6 mm
 H=4.72 | R=0.108 | V=0.24 in

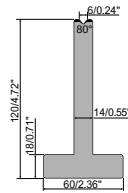

T120.08.80

835 mm 32.87" 16.5 kg
 415 mm 16.34" 8.2 kg
 795 mm 31.29" 15.7 kg FX
 805 mm 31.69" 15.9 kg F

C45: 560-710 N/mm²
 1000 kN/m max.

80°
 H=120 | R=2.75 | V=8 mm
 H=4.72 | R=0.108 | V=0.31 in

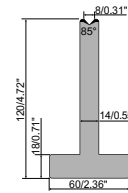

T120.10.80

835 mm 32.87" 19.0 kg
 415 mm 16.34" 9.4 kg
 795 mm 31.29" 18.1 kg FX
 805 mm 31.69" 18.3 kg F

C45: 560-710 N/mm²
 950 kN/m max.

80°
 H=120 | R=2.75 | V=10 mm
 H=4.72 | R=0.108 | V=0.39 in

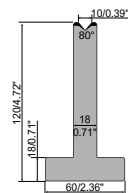

T120.12.80

835 mm 32.87" 18.9 kg
 415 mm 16.34" 9.4 kg
 795 mm 31.29" 18.0 kg FX
 805 mm 31.69" 18.2 kg F

C45: 560-710 N/mm²
 950 kN/m max.

80°
 H=120 | R=2.75 | V=12 mm
 H=4.72 | R=0.108 | V=0.47 in

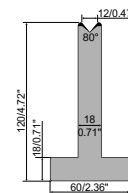

T120.16.80

835 mm 32.87" 22.0 kg
 415 mm 16.34" 10.9 kg
 795 mm 31.29" 20.9 kg FX
 805 mm 31.69" 21.2 kg F

C45: 560-710 N/mm²
 950 kN/m max.

80°
 H=120 | R=2.75 | V=16 mm
 H=4.72 | R=0.108 | V=0.63 in

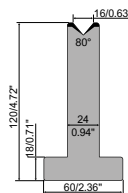

T120.20.80

835 mm 32.87" 27.0 kg
 415 mm 16.34" 13.4 kg
 795 mm 31.29" 25.7 kg FX
 805 mm 31.69" 26.0 kg F

C45: 560-710 N/mm²
 950 kN/m max.

80°
 H=120 | R=3 | V=20 mm
 H=4.72 | R=0.118 | V=0.79 in

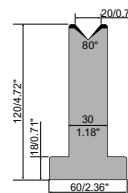

T120.25.80

835 mm 32.87" 30.0 kg
 415 mm 16.34" 14.9 kg
 795 mm 31.29" 28.6 kg FX
 805 mm 31.69" 28.9 kg F

C45: 560-710 N/mm²
 1000 kN/m max.

80°
 H=120 | R=3 | V=25 mm
 H=4.72 | R=0.118 | V=0.98 in

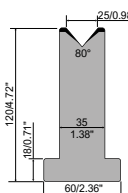

FX: 795 mm - 31.29"

mm: 100-250-20-25-30-35-40-45-50 -200

in: 3.94-9.84-0.78-0.98-1.18-1.37-1.57-1.77-1.96-7.87

F: 805 mm - 31.69"

mm: 200-50-40-20-15-10-370-100

in: 7.87-1.97-1.57-0.78-0.59-0.39-14.56-3.94





T80.06.60

835 mm 32.87" 13.0 kg
 415 mm 16.34" 6.5 kg
 795 mm 31.29" 12.4 kg FX
 805 mm 31.69" 12.5 kg F

60° >



C45: 560-710 N/mm²
 600 kN/m max.

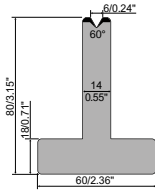

TR80.06.60

835 mm 32.87" 13 kg
 415 mm 16.34" 6.5 kg
 795 mm 31.29" 13 kg FX
 805 mm 31.69" 13 kg F



C45: 560-710 N/mm²
 600 kN/m max.

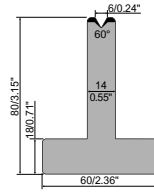

60°
 H=80 | R=1.5 | V=6 mm
 H=3.15 | R=0.06 | V=0.24 in

T80.08.60

835 mm 32.87" 13.0 kg
 415 mm 16.34" 6.5 kg
 795 mm 31.29" 12.4 kg FX
 805 mm 31.69" 12.5 kg F



C45: 560-710 N/mm²
 600 kN/m max.

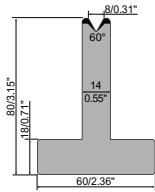

TR80.08.60

835 mm 32.87" 13 kg
 415 mm 16.34" 6.5 kg
 795 mm 31.29" 13 kg FX
 805 mm 31.69" 13 kg F



C45: 560-710 N/mm²
 600 kN/m max.

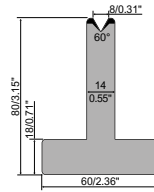

60°
 H=80 | R=1.5 | V=8 mm
 H=3.15 | R=0.06 | V=0.31 in

T80.10.60

835 mm 32.87" 14.9 kg
 415 mm 16.34" 7.4 kg
 795 mm 31.29" 14.2 kg FX
 805 mm 31.69" 14.4 kg F



C45: 560-710 N/mm²
 600 kN/m max.

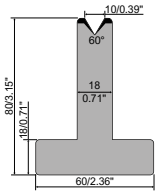

TR80.10.60

835 mm 32.87" 15 kg
 415 mm 16.34" 7.5 kg
 795 mm 31.29" 15 kg FX
 805 mm 31.69" 15 kg F



C45: 560-710 N/mm²
 600 kN/m max.

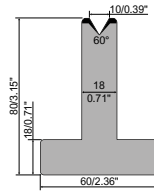

60°
 H=80 | R=2.75 | V=10 mm
 H=3.15 | R=0.108 | V=0.39 in

T80.12.60

835 mm 32.87" 14.9 kg
 415 mm 16.34" 7.4 kg
 795 mm 31.29" 14.2 kg FX
 805 mm 31.69" 14.4 kg F



C45: 560-710 N/mm²
 600 kN/m max.

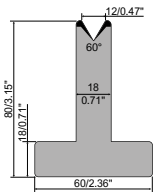

TR80.12.60

835 mm 32.87" 15 kg
 415 mm 16.34" 7.5 kg
 795 mm 31.29" 15 kg FX
 805 mm 31.69" 15 kg F



C45: 560-710 N/mm²
 1000 kN/m max.

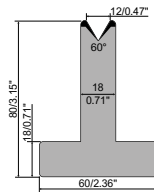

60°
 H=80 | R=2.75 | V=12 mm
 H=3.15 | R=0.11 | V=0.47 in

Bent sheet metal often shows two lines in the contact area with die. This is the consequence of friction between sheet metal and too small die radius. To avoid such bending marks you can use TR dies with bigger radius (we can also modify your dies) with **ROLFILM**



Click on the QR Code or scan it to watch the video and discover more about TR dies.

T80.16.60

835 mm	32.87"	16.1 kg
415 mm	16.34"	8.0 kg
795 mm	31.29"	15.3 kg FX
805 mm	31.69"	15.5 kg F

C45: 560-710 N/mm²
600 kN/m max.

60°
H=80 | R=2.75 | V=16 mm
H=3.15 | R=0.108 | V=0.63 in

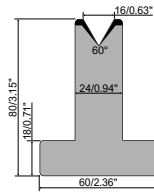

T80.20.60

835 mm	32.87"	18.0 kg
415 mm	16.34"	8.9 kg
795 mm	31.29"	17.1 kg FX
805 mm	31.69"	17.4 kg F

C45: 560-710 N/mm²
600 kN/m max.

60°
H=80 | R=3 | V=20 mm
H=3.15 | R=0.118 | V=0.79 in

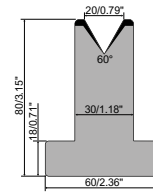

T80.25.60

835 mm	32.87"	19.5 kg
415 mm	16.34"	9.7 kg
795 mm	31.29"	18.6 kg FX
805 mm	31.69"	18.8 kg F

C45: 560-710 N/mm²
600 kN/m max.

60°
H=80 | R=3 | V=25 mm
H=3.15 | R=0.118 | V=0.98 in

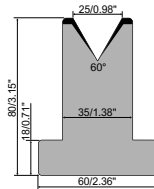

T120.06.60

835 mm	32.87"	16.0 kg
415 mm	16.34"	8.0 kg
795 mm	31.29"	15.2 kg FX
805 mm	31.69"	15.4 kg F

C45: 560-710 N/mm²
600 kN/m max.

60°
H=120 | R=0.5 | V=6 mm
H=4.72 | R=0.02 | V=0.24 in

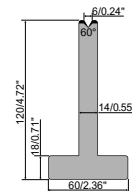

TR120.06.60

835 mm	32.87"	16.0 kg
415 mm	16.34"	8.0 kg
795 mm	31.29"	15.2 kg FX
805 mm	31.69"	15.4 kg F

C45: 560-710 N/mm²
600 kN/m max.

60°
H=120 | R=1.5 | V=6 mm
H=4.72 | R=0.06 | V=0.24 in

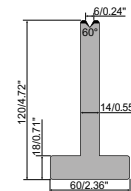

T120.08.60

835 mm	32.87"	16.0 kg
415 mm	16.34"	8.0 kg
795 mm	31.29"	15.2 kg FX
805 mm	31.69"	15.4 kg F

C45: 560-710 N/mm²
600 kN/m max.

60°
H=120 | R=0.8 | V=8 mm
H=4.72 | R=0.031 | V=0.31 in

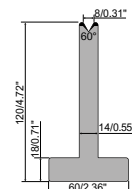

TR120.08.60

835 mm	32.87"	16.0 kg
415 mm	16.34"	8.0 kg
795 mm	31.29"	15.2 kg FX
805 mm	31.69"	15.4 kg F

C45: 560-710 N/mm²
600 kN/m max.

60°
H=120 | R=1.5 | V=8 mm
H=4.72 | R=0.06 | V=0.31 in

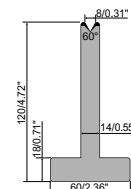

Bent sheet metal often shows two lines in the contact area with die. This is the consequence of friction between sheet metal and too small die radius. To avoid such bending marks you can use TR dies with bigger radius (we can also modify your dies) with [ROLFILM](#)



Click on the QR Code or scan it to watch the video and discover more about TR dies.

T120.10.60

835 mm 32.87" 18.0 kg
 415 mm 16.34" 8.9 kg
 795 mm 31.29" 17.1 kg FX
 805 mm 31.69" 17.4 kg F

C45: 560-710 N/mm²
 600 kN/m max.

60°
 H=120 | R=0.8 | V=10 mm
 H=4.72 | R=0.031 | V=0.39 in

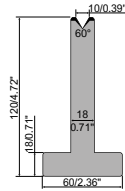

TR120.10.60

835 mm 32.87" 18.0 kg
 415 mm 16.34" 8.9 kg
 795 mm 31.29" 17.1 kg FX
 805 mm 31.69" 17.4 kg F

C45: 560-710 N/mm²
 600 kN/m max.

60°
 H=120 | R=2.75 | V=10 mm
 H=4.72 | R=0.108 | V=0.39 in

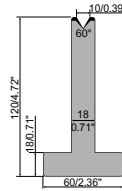

T120.12.60

835 mm 32.87" 18.0 kg
 415 mm 16.34" 8.9 kg
 795 mm 31.29" 17.1 kg FX
 805 mm 31.69" 17.4 kg F

C45: 560-710 N/mm²
 600 kN/m max.

60°
 H=120 | R=0.8 | V=12 mm
 H=4.72 | R=0.03 | V=0.47 in

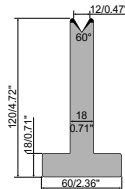

TR120.12.60

835 mm 32.87" 18.0 kg
 415 mm 16.34" 8.9 kg
 795 mm 31.29" 17.1 kg FX
 805 mm 31.69" 17.4 kg F

C45: 560-710 N/mm²
 600 kN/m max.

60°
 H=120 | R=2.75 | V=12 mm
 H=4.72 | R=0.108 | V=0.47 in

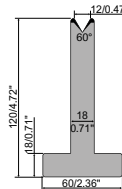

T120.16.60

835 mm 32.87" 22.4 kg
 415 mm 16.34" 11.1 kg
 795 mm 31.29" 21.3 kg FX
 805 mm 31.69" 21.6 kg F

C45: 560-710 N/mm²
 600 kN/m max.

60°
 H=120 | R=2.75 | V=16 mm
 H=4.72 | R=0.108 | V=0.63 in

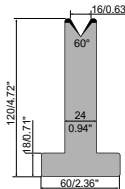

T120.20.60

835 mm 32.87" 26.0 kg
 415 mm 16.34" 12.9 kg
 795 mm 31.29" 24.8 kg FX
 805 mm 31.69" 25.1 kg F

C45: 560-710 N/mm²
 600 kN/m max.

60°
 H=120 | R=3 | V=20 mm
 H=4.72 | R=0.118 | V=0.79 in

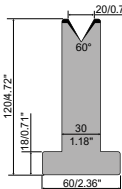

T120.25.60

835 mm 32.87" 28.5 kg
 415 mm 16.34" 14.2 kg
 795 mm 31.29" 27.1 kg FX
 805 mm 31.69" 27.5 kg F

C45: 560-710 N/mm²
 600 kN/m max.

60°
 H=120 | R=3 | V=25 mm
 H=4.72 | R=0.118 | V=0.98 in

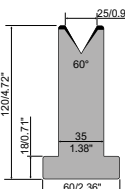

FX: 795 mm - 31.29"

mm: 100-250-20-25-30-35-40-45-50 -200

in: 3.94-9.84-0.78-0.98-1.18-1.37-1.57-1.77-1.96-7.87

F: 805 mm - 31.69"

mm: 200-50-40-20-15-10-370-100

in: 7.87-1.97-1.57-0.78-0.59-0.39-14.56-3.94



T80.06.45

835 mm	32.87"	12.6 kg
415 mm	16.34"	6.3 kg
795 mm	31.29"	12.0 kg FX
805 mm	31.69"	12.1 kg F

45° >



C45: 560-710 N/mm²
500 kN/m max.

45°
H=80 | R=0.8 | V=6 mm
H=3.15 | R=0.03 | V=0.24 in

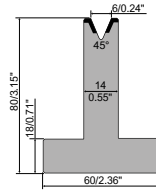

T80.08.45

835 mm	32.87"	14.2 kg
415 mm	16.34"	7.1 kg
795 mm	31.29"	13.5 kg FX
805 mm	31.69"	13.7 kg F



C45: 560-710 N/mm²
500 kN/m max.

45°
H=80 | R=1.0 | V=8 mm
H=3.15 | R=0.04 | V=0.31 in

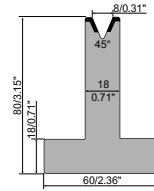

T80.10.45

835 mm	32.87"	14.0 kg
415 mm	16.34"	7.0 kg
795 mm	31.29"	13.3 kg FX
805 mm	31.69"	13.5 kg F



C45: 560-710 N/mm²
500 kN/m max.

45°
H=80 | R=1.2 | V=8 mm
H=3.15 | R=0.04 | V=0.31 in

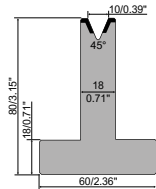

T80.12.45

835 mm	32.87"	16.2 kg
415 mm	16.34"	8.1 kg
795 mm	31.29"	15.4 kg FX
805 mm	31.69"	15.6 kg F



C45: 560-710 N/mm²
500 kN/m max.

45°
H=80 | R=1.6 | V=12 mm
H=3.15 | R=0.06 | V=0.47 in

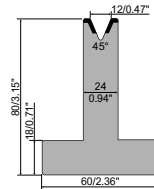

T80.16.45

835 mm	32.87"	16.6 kg
415 mm	16.34"	8.3 kg
795 mm	31.29"	15.8 kg FX
805 mm	31.69"	16.0 kg F



C45: 560-710 N/mm²
500 kN/m max.

45°
H=80 | R=2.75 | V=16 mm
H=3.15 | R=0.11 | V=0.63 in

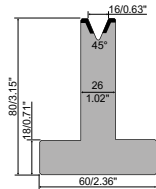

T80.20.45

835 mm	32.87"	18.0 kg
415 mm	16.34"	8.9 kg
795 mm	31.29"	17.1 kg FX
805 mm	31.69"	17.4 kg F



C45: 560-710 N/mm²
500 kN/m max.

45°
H=80 | R=3 | V=20 mm
H=3.15 | R=0.12 | V=0.79 in

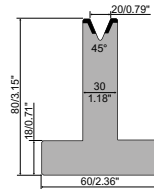

T80.25.45

835 mm	32.87"	20.0 kg
415 mm	16.34"	9.9 kg
795 mm	31.29"	19.0 kg FX
805 mm	31.69"	19.3 kg F



C45: 560-710 N/mm²
500 kN/m max.

45°
H=80 | R=3 | V=25 mm
H=3.15 | R=0.12 | V=0.98 in

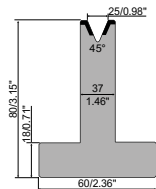

FX: 795 mm - 31.29"

mm: 100-250-20-25-30-35-40-45-50 -200

in: 3.94-9.84-0.78-0.98-1.18-1.37-1.57-1.77-1.96-7.87

F: 805 mm - 31.69"

mm: 200-50-40-20-15-10-370-100

In: 7.87-1.97-1.57-0.78-0.59-0.39-14.56-3.94



T120.06.45

835 mm 32.87" 16.0 kg
 415 mm 16.34" 8.0 kg
 795 mm 31.29" 15.2 kg FX
 805 mm 31.69" 15.4 kg F

C45: 560-710 N/mm²
 500 kN/m max.

45°
 H=120 | R=0.8 | V=6 mm
 H=4.72 | R=0.03 | V=0.24 in

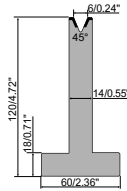

T120.08.45

835 mm 32.87" 18.0 kg
 415 mm 16.34" 8.9 kg
 795 mm 31.29" 17.1 kg FX
 805 mm 31.69" 17.4 kg F

C45: 560-710 N/mm²
 500 kN/m max.

45°
 H=120 | R=1 | V=8 mm
 H=4.72 | R=0.04 | V=0.31 in

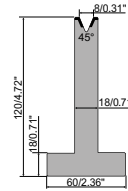

T120.10.45

835 mm 32.87" 18.0 kg
 415 mm 16.34" 8.9 kg
 795 mm 31.29" 17.1 kg FX
 805 mm 31.69" 17.4 kg F

C45: 560-710 N/mm²
 500 kN/m max.

45°
 H=120 | R=1.2 | V=10 mm
 H=4.72 | R=0.05 | V=0.39 in

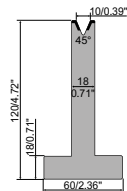

T120.12.45

835 mm 32.87" 22.9 kg
 415 mm 16.34" 11.4 kg
 795 mm 31.29" 21.8 kg FX
 805 mm 31.69" 22.1 kg F

C45: 560-710 N/mm²
 500 kN/m max.

45°
 H=120 | R=1.6 | V=12 mm
 H=4.72 | R=0.06 | V=0.47 in

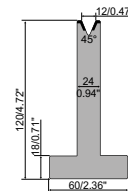

T120.16.45

835 mm 32.87" 25.0 kg
 415 mm 16.34" 12.4 kg
 795 mm 31.29" 23.8 kg FX
 805 mm 31.69" 24.1 kg F

C45: 560-710 N/mm²
 500 kN/m max.

45°
 H=120 | R=2.75 | V=16 mm
 H=4.72 | R=0.11 | V=0.63 in

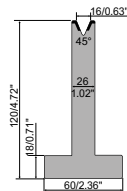

T120.20.45

835 mm 32.87" 26.0 kg
 415 mm 16.34" 12.9 kg
 795 mm 31.29" 24.8 kg FX
 805 mm 31.69" 25.1 kg F

C45: 560-710 N/mm²
 500 kN/m max.

45°
 H=120 | R=3 | V=20 mm
 H=4.72 | R=0.12 | V=0.79 in

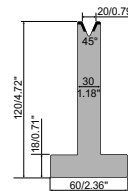

T120.25.45

835 mm 32.87" 30.0 kg
 415 mm 16.34" 14.9 kg
 795 mm 31.29" 28.6 kg FX
 805 mm 31.69" 28.9 kg F

C45: 560-710 N/mm²
 500 kN/m max.

45°
 H=120 | R=3 | V=25 mm
 H=4.72 | R=0.12 | V=0.98 in

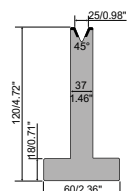

FX: 795 mm - 31.29"

mm: 100-250-20-25-30-35-40-45-50 -200

in: 3.94-9.84-0.78-0.98-1.18-1.37-1.57-1.77-1.96-7.87

F: 805 mm - 31.69"

mm: 200-50-40-20-15-10-370-100

in: 7.87-1.97-1.57-0.78-0.59-0.39-14.56-3.94



T80.06.35

835 mm 32.87" 12.5 kg
 415 mm 16.34" 6.2 kg
 795 mm 31.29" 11.9 kg FX
 805 mm 31.69" 12.1 kg F

35° >



C45: 560-710 N/mm²
 350 kN/m max.

35°
 H=80 | R=0.8 | V=6 mm
 H=3.15 | R=0.03 | V=0.24 in

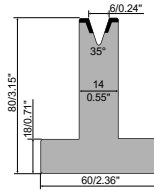

T80.08.35

835 mm 32.87" 13.0 kg
 415 mm 16.34" 6.5 kg
 795 mm 31.29" 12.4 kg FX
 805 mm 31.69" 12.5 kg F



C45: 560-710 N/mm²
 350 kN/m max.

35°
 H=80 | R=1 | V=8 mm
 H=3.15 | R=0.04 | V=0.31 in

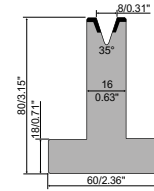

T80.10.35

835 mm 32.87" 14.7 kg
 415 mm 16.34" 7.3 kg
 795 mm 31.29" 14.0 kg FX
 805 mm 31.69" 14.2 kg F



C45: 560-710 N/mm²
 400 kN/m max.

35°
 H=80 | R=1.2 | V=10 mm
 H=3.15 | R=0.05 | V=0.39 in

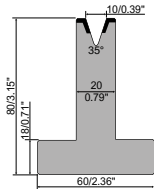

T80.12.35

835 mm 32.87" 15.5 kg
 415 mm 16.34" 7.7 kg
 795 mm 31.29" 14.8 kg FX
 805 mm 31.69" 14.9 kg F



C45: 560-710 N/mm²
 400 kN/m max.

35°
 H=80 | R=1.6 | V=12 mm
 H=3.15 | R=0.06 | V=0.47 in

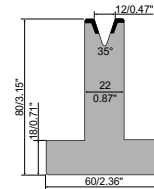

T80.16.35

835 mm 32.87" 18.0 kg
 415 mm 16.34" 8.9 kg
 795 mm 31.29" 17.1 kg FX
 805 mm 31.69" 17.4 kg F



C45: 560-710 N/mm²
 450 kN/m max.

35°
 H=80 | R=3 | V=16 mm
 H=3.15 | R=0.12 | V=0.63 in

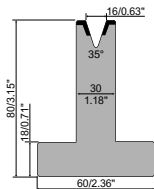

T80.20.35

835 mm 32.87" 19.3 kg
 415 mm 16.34" 9.6 kg
 795 mm 31.29" 18.4 kg FX
 805 mm 31.69" 18.6 kg F



C45: 560-710 N/mm²
 500 kN/m max.

35°
 H=80 | R=3 | V=20 mm
 H=3.15 | R=0.12 | V=0.79 in

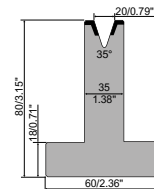

T80.25.35

835 mm 32.87" 20.0 kg
 415 mm 16.34" 9.0 kg
 795 mm 31.29" 19.0 kg FX
 805 mm 31.69" 19.3 kg F



C45: 560-710 N/mm²
 500 kN/m max.

35°
 H=80 | R=3 | V=25 mm
 H=3.15 | R=0.12 | V=0.98 in

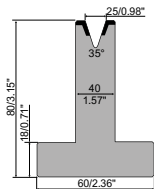

FX: 795 mm - 31.29"

mm: 100-250-20-25-30-35-40-45-50 -200

in: 3.94-9.84-0.78-0.98-1.18-1.37-1.57-1.77-1.96-7.87

F: 805 mm - 31.69"

mm: 200-50-40-20-15-10-370-100

In: 7.87-1.97-1.57-0.78-0.59-0.39-14.56-3.94





T120.06.35

835 mm 32.87" 16.0 kg
 415 mm 16.34" 8.0 kg
 795 mm 31.29" 15.2 kg FX
 805 mm 31.69" 15.4 kg F

C45: 560-710 N/mm²
 350 kN/m max.

35°

H=120 | R=0.8 | V=6 mm
 H=4.72 | R=0.03 | V=0.24 in

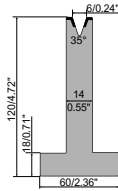

T120.08.35

835 mm 32.87" 18.0 kg
 415 mm 16.34" 8.9 kg
 795 mm 31.29" 17.1 kg FX
 805 mm 31.69" 17.4 kg F

C45: 560-710 N/mm²
 350 kN/m max.

35°

H=120 | R=1.0 | V=8 mm
 H=4.72 | R=0.04 | V=0.31 in

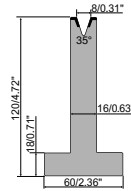

T120.10.35

835 mm 32.87" 19.9 kg
 415 mm 16.34" 9.9 kg
 795 mm 31.29" 18.9 kg FX
 805 mm 31.69" 19.2 kg F

C45: 560-710 N/mm²
 400 kN/m max.

35°

H=120 | R=1.2 | V=10 mm
 H=4.72 | R=0.05 | V=0.39 in

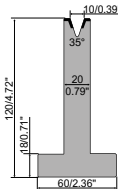

T120.12.35

835 mm 32.87" 21.0 kg
 415 mm 16.34" 10.4 kg
 795 mm 31.29" 20.0 kg FX
 805 mm 31.69" 20.2 kg F

C45: 560-710 N/mm²
 400 kN/m max.

35°

H=120 | R=1.6 | V=12 mm
 H=4.72 | R=0.06 | V=0.47 in

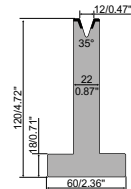

T120.16.35

835 mm 32.87" 25.8 kg
 415 mm 16.34" 12.8 kg
 795 mm 31.29" 24.6 kg FX
 805 mm 31.69" 24.9 kg F

C45: 560-710 N/mm²
 450 kN/m max.

35°

H=120 | R=3 | V=16 mm
 H=4.72 | R=0.12 | V=0.63 in

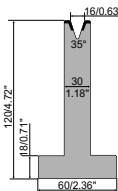

T120.20.35

835 mm 32.87" 28.0 kg
 415 mm 16.34" 13.9 kg
 795 mm 31.29" 26.7 kg FX
 805 mm 31.69" 27.0 kg F

C45: 560-710 N/mm²
 500 kN/m max.

35°

H=120 | R=3 | V=20 mm
 H=4.72 | R=0.12 | V=0.79 in

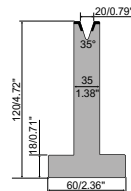

T120.25.35

835 mm 32.87" 30.5 kg
 415 mm 16.34" 15.2 kg
 795 mm 31.29" 29.0 kg FX
 805 mm 31.69" 29.4 kg F

C45: 560-710 N/mm²
 500 kN/m max.

35°

H=120 | R=3 | V=25 mm
 H=4.72 | R=0.12 | V=0.98 in

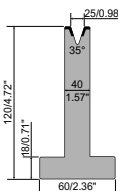

FX: 795 mm - 31.29"

mm: 100-250-20-25-30-35-40-45-50 -200

in: 3.94-9.84-0.78-0.98-1.18-1.37-1.57-1.77-1.96-7.87

F: 805 mm - 31.69"

mm: 200-50-40-20-15-10-370-100

in: 7.87-1.97-1.57-0.78-0.59-0.39-14.56-3.94



T80.06.30

835 mm 32.87" 12.4 kg
 415 mm 16.34" 6.2 kg
 795 mm 31.29" 11.8 kg FX
 805 mm 31.69" 12.0 kg F

30° >

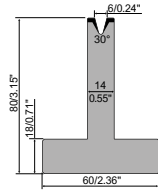

C45: 560-710 N/mm²
 350 kN/m max.

30°
 H=80 | R=0.6 | V=6 mm
 H=3.15 | R=0.024 | V=0.24 in

T80.08.30

835 mm 32.87" 13.0 kg
 415 mm 16.34" 6.5 kg
 795 mm 31.29" 12.4 kg FX
 805 mm 31.69" 12.5 kg F

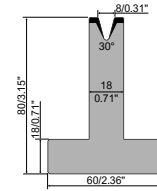

C45: 560-710 N/mm²
 350 kN/m max.

30°
 H=80 | R=0.8 | V=8 mm
 H=3.15 | R=0.031 | V=0.31 in

T80.10.30

835 mm 32.87" 16.0 kg
 415 mm 16.34" 8.0 kg
 795 mm 31.29" 15.2 kg FX
 805 mm 31.69" 15.4 kg F

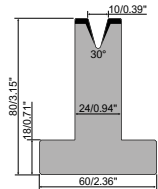

C45: 560-710 N/mm²
 500 kN/m max.

30°
 H=80 | R=1 | V=10 mm
 H=3.15 | R=0.039 | V=0.39 in

T80.12.30

835 mm 32.87" 16.0 kg
 415 mm 16.34" 8.0 kg
 795 mm 31.29" 15.2 kg FX
 805 mm 31.69" 15.4 kg F

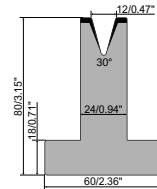

C45: 560-710 N/mm²
 400 kN/m max.

30°
 H=80 | R=1.5 | V=12 mm
 H=3.15 | R=0.059 | V=0.47 in

T80.16.30

835 mm 32.87" 18.0 kg
 415 mm 16.34" 8.9 kg
 795 mm 31.29" 17.1 kg FX
 805 mm 31.69" 17.4 kg F

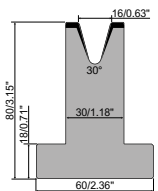

C45: 560-710 N/mm²
 450 kN/m max.

30°
 H=80 | R=2 | V=16 mm
 H=3.15 | R=0.079 | V=0.63 in

T80.20.30

835 mm 32.87" 19.0 kg
 415 mm 16.34" 9.4 kg
 795 mm 31.29" 18.1 kg FX
 805 mm 31.69" 18.3 kg F

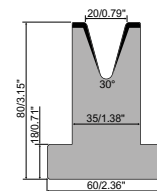

C45: 560-710 N/mm²
 500 kN/m max.

30°
 H=80 | R=2.5 | V=20 mm
 H=3.15 | R=0.098 | V=0.79 in

T80.25.30

835 mm 32.87" 19.6 kg
 415 mm 16.34" 9.7 kg
 795 mm 31.29" 18.7 kg FX
 805 mm 31.69" 18.9 kg F

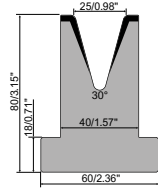

C45: 560-710 N/mm²
 500 kN/m max.

30°
 H=80 | R=3 | V=25 mm
 H=3.15 | R=0.12 | V=0.98 in

FX: 795 mm - 31.29"
 mm: 100-250-20-25-30-35-40-45-50 -200
 in: 3.94-9.84-0.78-0.98-1.18-1.37-1.57-1.77-1.96-7.87

F: 805 mm - 31.69"
 mm: 200-50-40-20-15-10-370-100
 in: 7.87-1.97-1.57-0.78-0.59-0.39-14.56-3.94



T120.06.30

835 mm 32.87" 16.0 kg
 415 mm 16.34" 8.0 kg
 795 mm 31.29" 15.2 kg FX
 805 mm 31.69" 15.4 kg F



C45: 560-710 N/mm²
 350 kN/m max.

30°
 H=120 | R=0.6 | V=6 mm
 H=4.72 | R=0.024 | V=0.24 in

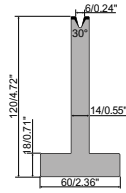

T120.08.30

835 mm 32.87" 19.0 kg
 415 mm 16.34" 9.4 kg
 795 mm 31.29" 18.1 kg FX
 805 mm 31.69" 18.3 kg F



C45: 560-710 N/mm²
 350 kN/m max.

30°
 H=120 | R=0.8 | V=8 mm
 H=4.72 | R=0.031 | V=0.31 in

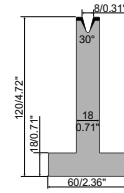

T120.10.30

835 mm 32.87" 22.0 kg
 415 mm 16.34" 10.9 kg
 795 mm 31.29" 20.9 kg FX
 805 mm 31.69" 21.2 kg F



C45: 560-710 N/mm²
 500 kN/m max.

30°
 H=120 | R=1 | V=10 mm
 H=4.72 | R=0.039 | V=0.39 in

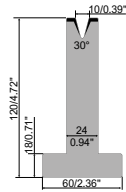

T120.12.30

835 mm 32.87" 22.0 kg
 415 mm 16.34" 10.9 kg
 795 mm 31.29" 20.9 kg FX
 805 mm 31.69" 21.2 kg F



C45: 560-710 N/mm²
 400 kN/m max.

30°
 H=120 | R=1.5 | V=12 mm
 H=4.72 | R=0.024 | V=0.47 in

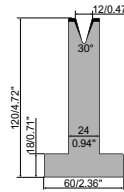

T120.16.30

835 mm 32.87" 25.8 kg
 415 mm 16.34" 12.8 kg
 795 mm 31.29" 24.6 kg FX
 805 mm 31.69" 24.9 kg F



C45: 560-710 N/mm²
 450 kN/m max.

30°
 H=120 | R=2 | V=16 mm
 H=4.72 | R=0.079 | V=0.63 in

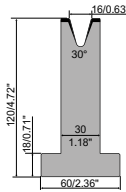

T120.20.30

835 mm 32.87" 28.0 kg
 415 mm 16.34" 13.9 kg
 795 mm 31.29" 26.7 kg FX
 805 mm 31.69" 27.0 kg F



C45: 560-710 N/mm²
 500 kN/m max.

30°
 H=120 | R=2.5 | V=20 mm
 H=4.72 | R=0.098 | V=0.79 in

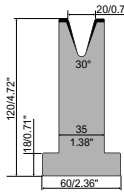

T120.25.30

835 mm 32.87" 30.5 kg
 415 mm 16.34" 15.2 kg
 795 mm 31.29" 29.0 kg FX
 805 mm 31.69" 29.4 kg F



C45: 560-710 N/mm²
 500 kN/m max.

30°
 H=120 | R=3 | V=25 mm
 H=4.72 | R=0.118 | V=0.98 in

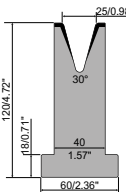

FX: 795 mm - 31.29"

mm: 100-250-20-25-30-35-40-45-50 -200

in: 3.94-9.84-0.78-0.98-1.18-1.37-1.57-1.77-1.96-7.87

F: 805 mm - 31.69"

mm: 200-50-40-20-15-10-370-100

in: 7.87-1.97-1.57-0.78-0.59-0.39-14.56-3.94



T80.06.26

835 mm 32.87" 14.0 kg
 415 mm 16.34" 7.0 kg
 795 mm 31.29" 13.3 kg FX
 805 mm 31.69" 13.5 kg F

26° >



C45: 560-710 N/mm²
 200 kN/m max.

26°
 H=80 | R=0.8 | V=6 mm
 H=3.15 | R=0.031 | V=0.24 in

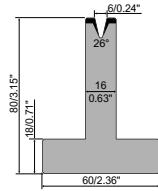

T80.08.26

835 mm 32.87" 15.0 kg
 415 mm 16.34" 7.5 kg
 795 mm 31.29" 14.3 kg FX
 805 mm 31.69" 14.5 kg F



C45: 560-710 N/mm²
 200 kN/m max.

26°
 H=80 | R=1 | V=8 mm
 H=3.15 | R=0.039 | V=0.31 in

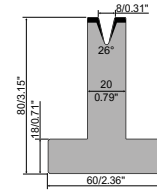

T80.10.26

835 mm 32.87" 15.5 kg
 415 mm 16.34" 7.7 kg
 795 mm 31.29" 14.8 kg FX
 805 mm 31.69" 14.9 kg F



C45: 560-710 N/mm²
 200 kN/m max.

26°
 H=80 | R=1.2 | V=10 mm
 H=3.15 | R=0.047 | V=0.39 in

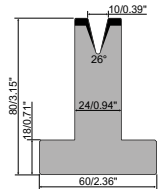

T80.12.26

835 mm 32.87" 16.6 kg
 415 mm 16.34" 8.3 kg
 795 mm 31.29" 15.8 kg FX
 805 mm 31.69" 16.0 kg F



C45: 560-710 N/mm²
 200 kN/m max.

26°
 H=80 | R=1.6 | V=12 mm
 H=3.15 | R=0.063 | V=0.47 in

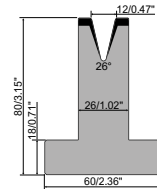

T120.06.26

835 mm 32.87" 18.0 kg
 415 mm 16.34" 8.9 kg
 795 mm 31.29" 17.1 kg FX
 805 mm 31.69" 17.4 kg F



C45: 560-710 N/mm²
 200 kN/m max.

26°
 H=120 | R=0.8 | V=6 mm
 H=4.72 | R=0.031 | V=0.24 in

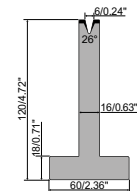

T120.08.26

835 mm 32.87" 19.0 kg
 415 mm 16.34" 9.4 kg
 795 mm 31.29" 18.1 kg FX
 805 mm 31.69" 18.3 kg F



C45: 560-710 N/mm²
 200 kN/m max.

26°
 H=120 | R=1 | V=8 mm
 H=4.72 | R=0.039 | V=0.31 in

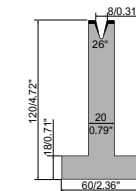

T120.10.26

835 mm 32.87" 22.0 kg
 415 mm 16.34" 10.9 kg
 795 mm 31.29" 20.9 kg FX
 805 mm 31.69" 21.2 kg F



C45: 560-710 N/mm²
 200 kN/m max.

26°
 H=120 | R=1.2 | V=10 mm
 H=4.72 | R=0.047 | V=0.39 in

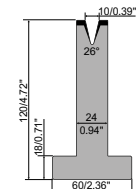

T120.12.26

835 mm 32.87" 23.4 kg
 415 mm 16.34" 11.6 kg
 795 mm 31.29" 22.3 kg FX
 805 mm 31.69" 22.6 kg F



C45: 560-710 N/mm²
 200 kN/m max.

26°
 H=120 | R=1.6 | V=12 mm
 H=4.72 | R=0.063 | V=0.47 in

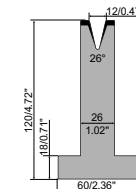

FX: 795 mm - 31.29"

mm: 100-250-20-25-30-35-40-45-50 -200

in: 3.94-9.84-0.78-0.98-1.18-1.37-1.57-1.77-1.96-7.87

F: 805 mm - 31.69"

mm: 200-50-40-20-15-10-370-100

in: 7.87-1.97-1.57-0.78-0.59-0.39-14.56-3.94





M60.85.32



835 mm 32.87" 21.6 kg
 415 mm 16.34" 10.7 kg
 795 mm 31.29" 20.6 kg FX
 805 mm 31.69" 20.8 kg F

85° >

C45: 560-710 N/mm²
 1000 kN/m max.
 85°
 H=60 | R=4 | V=32 mm
 H=2.36 | R=0.157 | V=1.26 in

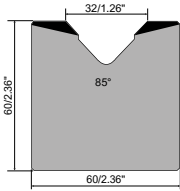

M60.85.40



835 mm 32.87" 20 kg
 415 mm 16.34" 10.5 kg
 795 mm 31.29" 19.0 kg FX
 805 mm 31.69" 19.0 kg F

C45: 560-710 N/mm²
 1000 kN/m max.
 85°
 H=60 | R=4 | V=40 mm
 H=2.36 | R=0.157 | V=1.57 in

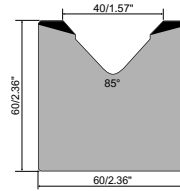

M60.85.50



835 mm 32.87" 19.0 kg
 415 mm 16.34" 9.5.0 kg
 795 mm 31.29" 19.0 kg FX
 805 mm 31.69" 19.0 kg F

C45: 560-710 N/mm²
 1000 kN/m max.
 85°
 H=60 | R=4 | V=50 mm
 H=2.36 | R=0.157 | V=1.97 in

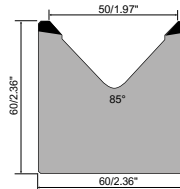

M75.85.63



835 mm 32.87" 29.2 kg
 415 mm 16.34" 14.5 kg
 795 mm 31.29" 28.0 kg FX
 805 mm 31.69" 28.0 kg F

C45: 560-710 N/mm²
 1000 kN/m max.
 85°
 H=60 | R=5 | V=63 mm
 H=2.36 | R=0.197 | V=2.48 in

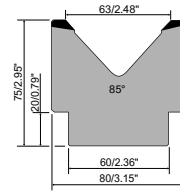

M80.85.80



835 mm 32.87" 33.5 kg
 415 mm 16.34" 16.6 kg
 795 mm 31.29" 32.2 kg FX
 805 mm 31.69" 32.2 kg F

C45: 560-710 N/mm²
 1000 kN/m max.
 85°
 H=60 | R=6 | V=80 mm
 H=2.36 | R=0.236 | V=3.15 in

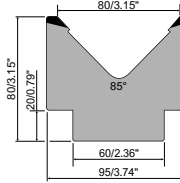

M95.80.100



80° >

835 mm 32.87" 46.2 kg
 415 mm 16.34" 22.9 kg
 795 mm 31.29" 44.5 kg FX
 805 mm 31.69" 44.5 kg F

C45: 560-710 N/mm²
 1000 kN/m max.
 80°
 H=60 | R=8 | V=100 mm
 H=2.36 | R=0.315 | V=3.94 in

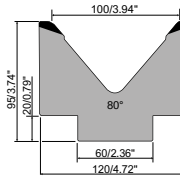

FX: 795 mm - 31.29"

mm: 100-250-20-25-30-35-40-45-50 -200

in: 3.94-9.84-0.78-0.98-1.18-1.37-1.57-1.77-1.96-7.87

F: 805 mm - 31.69"

mm: 200-50-40-20-15-10-370-100

in: 7.87-1.97-1.57-0.78-0.59-0.39-14.56-3.94



MK103.80.125

835 mm 32.87" 62 kg
 415 mm 16.34" 31 kg
 795 mm 31.29" 59.8 kg FX
 805 mm 31.69" 59.8 kg F



C45: 560-710 N/mm²
 700 kN/m max.

85°
 H=103 | R=15 | V=125 mm
 H=4.06 | R=0.591 | V=4.92 in

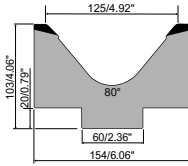

M103.80.125

835 mm 32.87" 64.9 kg
 415 mm 16.34" 32.2 kg
 795 mm 31.29" 62.5 kg FX
 805 mm 31.69" 62.5 kg F



C45: 560-710 N/mm²
 1000 kN/m max.

85°
 H=103 | R=15 | V=125 mm
 H=4.06 | R=0.591 | V=4.92 in

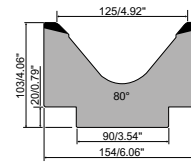

MK130.80.160

835 mm 32.87" 93 kg
 415 mm 16.34" 46.5 kg
 795 mm 31.29" 88.5 kg FX
 805 mm 31.69" 89.7 kg F



C45: 560-710 N/mm²
 700 kN/m max.

80°
 H=130 | R=10 | V=160 mm
 H=5.12 | R=0.394 | V=6.30 in

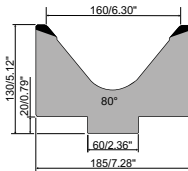

M130.80.160

835 mm 32.87" 97 kg
 415 mm 16.34" 47.4 kg
 795 mm 31.29" 88.5 kg FX
 805 mm 31.69" 89.7 kg F



C45: 560-710 N/mm²
 1000 kN/m max.

80°
 H=130 | R=10 | V=160 mm
 H=5.12 | R=0.394 | V=6.30 in

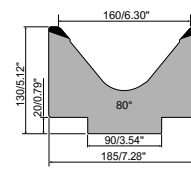

M195.70.200

415 mm 16.34" 104 kg



42Cr: 900-1150 N/mm²
 1800 kN/m max.

70°
 H=195 | R=15 | V=200 mm
 H=7.68 | R=0.591 | V=7.87 in

70° >

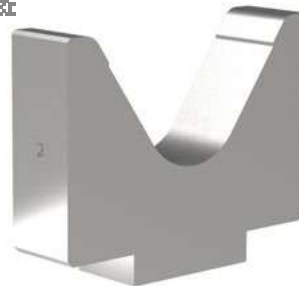
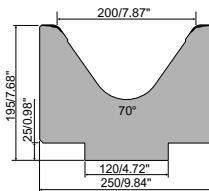

M86.60.63

835 mm 32.87" 33.3 kg
 415 mm 16.34" 17 kg
 795 mm 31.29" 34.0 kg FX
 805 mm 31.69" 34.0 kg F



C45: 560-710 N/mm²
 1000 kN/m max.

60°
 H=85 | R=5 | V=63 mm
 H=3.39 | R=0.197 | V=2.48 in

60° >

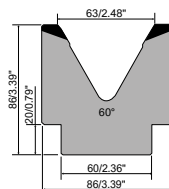

FX: 795 mm - 31.29"

mm: 100-250-20-25-30-35-40-45-50 -200

in: 3.94-9.84-0.78-0.98-1.18-1.37-1.57-1.77-1.96-7.87

F: 805 mm - 31.69"

mm: 200-50-40-20-15-10-370-100

in: 7.87-1.97-1.57-0.78-0.59-0.39-14.56-3.94





M110.60.80



835 mm 32.87" 53 kg
 415 mm 16.34" 26.5 kg
 795 mm 31.29" 50.5 kg FX
 805 mm 31.69" 51.1 kg F

C45: 560-710 N/mm²
 1000 kN/m max.

60°
 H=110 | R=6 | V=80 mm
 H=4.33 | R=0.236 | V=3.15 in

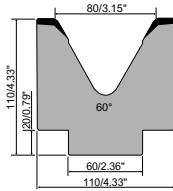

M80.45.32



835 mm 32.87" 27.5 kg
 415 mm 16.34" 13.7 kg
 795 mm 31.29" 27.5 kg FX
 805 mm 31.69" 27.5 kg F

C45: 560-710 N/mm²
 1000 kN/m max.

45°
 H=80 | R=4 | V=32 mm
 H=3.15 | R=0.157 | V=1.26 in

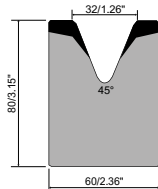

M80.45.40



835 mm 32.87" 30.9 kg
 415 mm 16.34" 16.5 kg
 795 mm 31.29" 30.7 kg FX
 805 mm 31.69" 30.7 kg F

C45: 560-710 N/mm²
 1000 kN/m max.

45°
 H=80 | R=4 | V=40 mm
 H=3.15 | R=0.157 | V=1.57 in

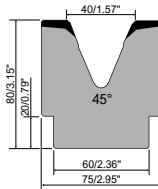

M80.45.50



835 mm 32.87" 31 kg
 415 mm 16.34" 15.5 kg
 795 mm 31.29" 31 kg FX
 805 mm 31.69" 31 kg F

C45: 560-710 N/mm²
 950 kN/m max.

45°
 H=80 | R=4 | V=50 mm
 H=3.15 | R=0.157 | V=1.97 in

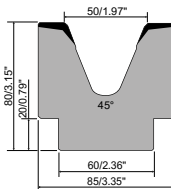

FX: 795 mm - 31.29"

mm: 100-250-20-25-30-35-40-45-50 -200

in: 3.94-9.84-0.78-0.98-1.18-1.37-1.57-1.77-1.96-7.87

F: 805 mm - 31.69"

mm: 200-50-40-20-15-10-370-100

in: 7.87-1.97-1.57-0.78-0.59-0.39-14.56-3.94





M60.90.01

835 mm	32.87"	20 kg
415 mm	16.34"	10.0 kg
795 mm	31.29"	20 kg FX
805 mm	31.69"	20 kg F



C45: 560-710 N/mm²
950 kN/m max.

90°
R=0.4 | V=6 mm
R=0.6 | V=10 mm
R=0.016 | V=0.24 in
R=0.024 | V=0.39 in

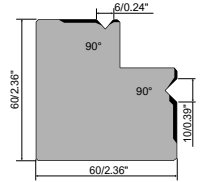

M60.90.02

835 mm	32.87"	20 kg
415 mm	16.34"	10.0 kg
795 mm	31.29"	20 kg FX
805 mm	31.69"	20 kg F



C45: 560-710 N/mm²
1000 kN/m max.

90°
R=0.5 | V=8 mm
R=0.8 | V=12 mm
R=0.020 | V=0.31 in
R=0.031 | V=0.47 in

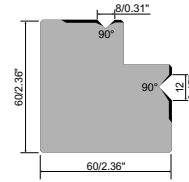

M.360.R

835 mm	32.87"	20 kg
415 mm	16.34"	10.0 kg
795 mm	31.29"	20 kg FX
805 mm	31.69"	20 kg F



C45: 560-710 N/mm²
1000 kN/m max.

R=1.5 | V=6 mm R=0.059 | V=0.24 in
R=2 | V=10 mm R=0.079 | V=0.39 in
R=2 | V=18 mm R=0.118 | V=0.71 in

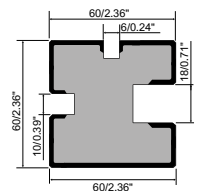

M.460

835 mm	32.87"	15.7 kg
415 mm	16.34"	7.7 kg
795 mm	31.29"	15.5 kg FX
805 mm	31.69"	15.5 kg F



C45: 560-710 N/mm²
800 kN/m max.

85° R=2 | V=35 mm R=0.079 | V=1.38 in
85° R=3 | V=50 mm R=0.118 | V=1.97 in
88° R=2 | V=16 mm R=0.079 | V=0.63 in
88° R=3 | V=60 mm R=0.079 | V=2.36 in

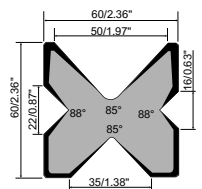

M.460.R

835 mm	32.87"	15.7 kg
415 mm	16.34"	7.7 kg
795 mm	31.29"	15.1 kg FX
805 mm	31.69"	15.1 kg F



C45: 560-710 N/mm²
800 kN/m max.

85°
R=2 | V=16 mm R=0.079 | V=0.63 in
R=2 | V=35 mm R=0.079 | V=1.38 in
R=2 | V=60 mm R=0.079 | V=2.36 in
R=3 | V=50 mm R=0.118 | V=1.97 in

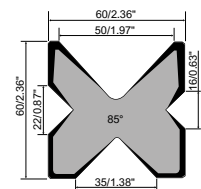

M.460.60

835 mm	32.87"	18.0 kg
415 mm	16.34"	9.0 kg
795 mm	31.29"	16 kg FX
805 mm	31.69"	16 kg F



C45: 560-710 N/mm²
600 kN/m max.

60°
R=1.5 | V=10 mm R=0.059 | V=0.39 in
R=2.0 | V=16 mm R=0.079 | V=0.63 in
R=2.5 | V=22 mm R=0.098 | V=0.87 in
R=3.0 | V=35 mm R=0.118 | V=1.38 in

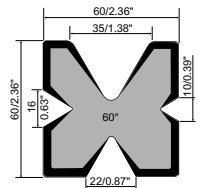

FX: 795 mm - 31.29"

mm: 100-250-20-25-30-35-40-45-50 -200

in: 3.94-9.84-0.78-0.98-1.18-1.37-1.57-1.77-1.96-7.87

F: 805 mm - 31.69"

mm: 200-50-40-20-15-10-370-100

in: 7.87-1.97-1.57-0.78-0.59-0.39-14.56-3.94





M.490

835 mm 32.87" 38.9 kg
 415 mm 16.34" 20 kg
 795 mm 31.29" 39.0 kg FX
 805 mm 31.69" 39.0 kg F



C45: 560-710 N/mm²
 1000 kN/m max.

60° R=2 | V=20 mm R=0.079 | V=0.79 in
 80° R=4 | V=30 mm R=0.157 | V=1.18 in
 80° R=4 | V=45 mm R=0.157 | V=1.77 in
 80° R=5 | V=60 mm R=0.020 | V=2.36 in

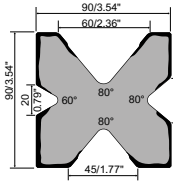

M.490.70

835 mm 32.87" 35.8 kg
 415 mm 16.34" 17.9 kg
 795 mm 31.29" 36 kg FX
 805 mm 31.69" 36 kg F

C45: 560-710 N/mm²
 600 kN/m max.

60° R=2 | V=20 mm R=0.079 | V=0.79 in
 80° R=4 | V=30 mm R=0.157 | V=1.18 in
 80° R=4 | V=45 mm R=0.157 | V=1.77 in
 80° R=5 | V=70 mm R=0.020 | V=2.76 in

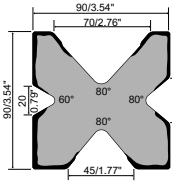

T70-88

525 mm 20.67" 17.5 kg
 495 mm 19.49" 16.5 kg



42Cr: 900-1150 N/mm²
 1000 kN/m max.

88°
 R=0.4 | V=6 mm R=0.016 | V=0.24 in
 R=0.5 | V=8 mm R=0.020 | V=0.31 in
 R=0.8 | V=10 mm R=0.031 | V=0.39 in
 R=2.75 | V=12 mm R=0.108 | V=0.47 in
 R=2.75 | V=16 mm R=0.108 | V=0.63 in
 R=3.0 | V=20 mm R=0.118 | V=0.79 in

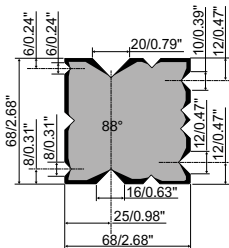

T70-60

525 mm 20.67" 16.8 kg
 495 mm 19.49" 15.8 kg



42Cr: 900-1150 N/mm²

60° kN/m max.
 R=0.8 | V=10 mm R=0.031 | V=0.39 in 600
 R=0.8 | V=12 mm R=0.031 | V=0.47 in 600
 R=2.75 | V=16 mm R=0.108 | V=0.63 in 800
 R=0.8 | V=8 mm R=0.031 | V=0.31 in 600
 R=0.5 | V=6 mm R=0.020 | V=0.24 in 600
 R=3.0 | V=20 mm R=0.118 | V=0.79 in 800

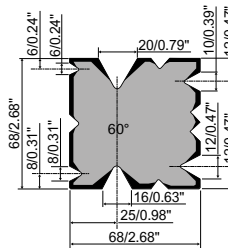

T70-45

525 mm 20.67" 16.1 kg
 495 mm 19.49" 15.2 kg



42Cr: 900-1150 N/mm²

45° kN/m max.
 R=0.8 | V=6 mm R=0.031 | V=0.24 in 400
 R=1.0 | V=8 mm R=0.039 | V=0.31 in 400
 R=1.2 | V=10 mm R=0.047 | V=0.39 in 500
 R=1.6 | V=12 mm R=0.063 | V=0.47 in 500
 R=2.75 | V=16 mm R=0.108 | V=0.63 in 700
 R=3.0 | V=20 mm R=0.118 | V=0.79 in 700

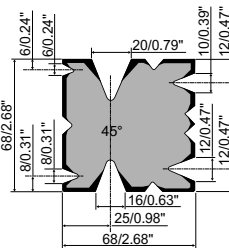

T70-35

525 mm 20.67" 15.3 kg
 495 mm 19.49" 14.4 kg



42Cr: 900-1150 N/mm²

35° kN/m max.
 R=0.8 | V=6 mm R=0.031 | V=0.24 in 300
 R=1.0 | V=8 mm R=0.039 | V=0.31 in 350
 R=1.2 | V=10 mm R=0.047 | V=0.39 in 450
 R=1.6 | V=12 mm R=0.063 | V=0.47 in 450
 R=3.0 | V=16 mm R=0.118 | V=0.63 in 500
 R=3.0 | V=20 mm R=0.118 | V=0.79 in 500

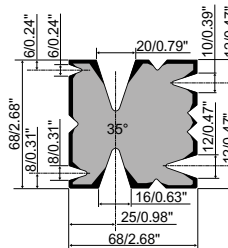

SU-T70

525 mm 20.67" 12.4 kg



C45: 560-710 N/mm²

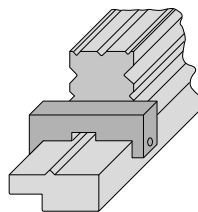
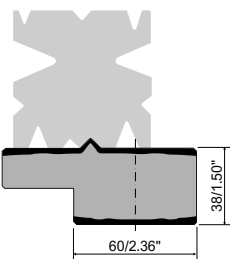

PB-T70

525 mm 20.67" 12.4 kg

Fe37

Retainer

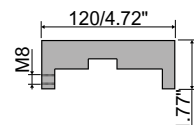

Scan the QRCode or click on it and watch the video to discover more about T70



Create your account on www.rolleritools.com

You can use Rolleri website to check the delivery time, request quotes, stay update with the news, check prices and place orders directly.

Hemming tools are used to prebend and afterwards flatten a sheet metal edge by using the same tool set.

Thanks to this operation you can strengthen sheet metal edges and avoid burr on their external side. For this reason, this operation is especially used for safety reason, in order to avoid operators' accidental injuries which may occur to those who have to handle sheet metal parts.

The maximum sheet metal thickness usually recommended for this operation is 3mm mild steel and 2mm stainless steel. However, for thicker sheet metal special solutions can be proposed, which consider the necessary bending force involved to flatten.

There are 2 types of flattening: partial flattening and total flattening.

Partial flattening is a kind of flattening which doesn't win against the sheet metal springback. For this reason, if you measure the flattened point, it won't be twice the sheet metal thickness but a bigger measure; for example, if you flatten 1.5mm partially, the flattened point will be about 4mm. This dimension depends on the bending force only. Hence, if you want to flatten 1.5mm mild steel and get 3mm high flattened point, you have to increase the tonnage.

In the table below you can check the necessary tonnage according to sheet metal thickness and type.

The choice of hemming tools should be influenced by the sheet metal type to be flattened; 35° punch and dies are recommended to flatten aluminium and mild steel, which have small springback, whereas more resistant sheet metal types like stainless steel require at least 30°, or better 26°, punch and die.

Springback control is fundamental to win against sheet metal resistance during the flattening phase. In fact, if the angle obtained during the pre-bending phase is too wide, sheet metal will slip towards the operator during the flattening phase.

In case you want to flatten sheet metal by using spring-loaded or pneumatic hemming dies, the chosen punch must have exactly the same angle of the die. Such dies are available in 835mm and 415mm length and they cannot be sectioned.

The choice of TOP serie hemming tools with dies with U shape opening has to take into consideration the fact that the U opening of the die has to match perfectly with the punch tip width. These tools are 525mm long and the sectioned set is also available.

MAX. CAPACITY

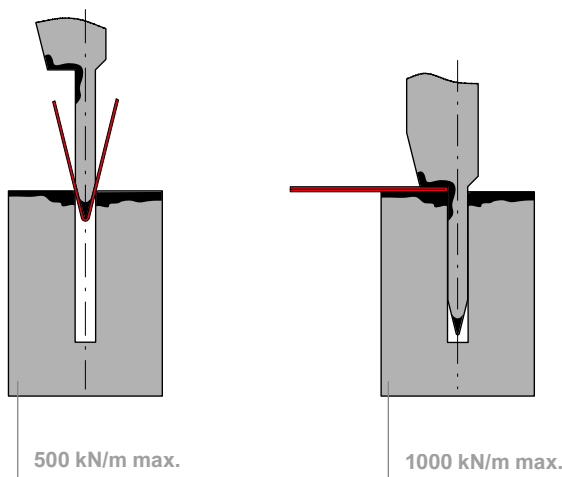

					
S	S	A	A	R.420 N/mm ²	R.700 N/mm ²
mm	in	mm	in	kN/m	kN/m
0.60	0.02	3.0	0.12	90	150
0.80	0.03	3.0	0.12	120	200
1.00	0.04	3.5	0.14	150	250
1.25	0.05	3.5	0.14	170	260

					
S	S	A	A	R.420 N/mm ²	R.700 N/mm ²
mm	in	mm	in	kN/m	kN/m
0.60	0.02	1.2	0.05	230	350
0.80	0.03	1.6	0.06	320	500
1.00	0.04	1.0	0.04	400	600
1.25	0.05	2.5	0.10	500	800



The **Bending handbook** target is to supply practice and useful information to reach quickly the required result. A lot of examples, easy formulas and information which explain the proper attitude towards the bending process.



Scan the QRCode or click on it and watch the video to discover more about hemming tools.

TOP.SM-134.28.8

525 mm 20.67" 17.5 kg
495 mm 19.49" 16.5 kg FC

42Cr:900-1150 N/mm²
500 - 1000 kN/m max.

H=80 | R=1 | V=8 mm
H=3.15 | R=0.039 | V=0.31 in



To use with:
TOP.SP.134.28.8

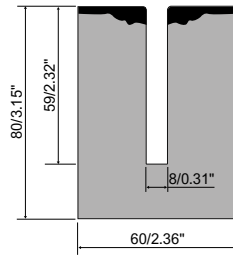

TOP.SM-134.24.8

525 mm 20.67" 16.5 kg
495 mm 19.49" 16.5 kg FC

42Cr:900-1150 N/mm²
500 - 1000 kN/m max.

H=80 | R=1 | V=8 mm
H=3.15 | R=0.039 | V=0.31 in



To use with:
TOP.SP.134.24.8

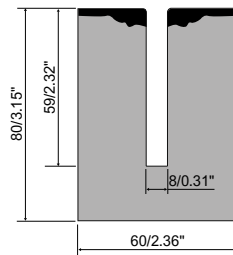

TOP.SM-134.24.10

525 mm 20.67" 18.0 kg
495 mm 19.49" 16.9 kg FC

42Cr:900-1150 N/mm²
500 - 1000 kN/m max.

H=80 | R=1 | V=10 mm
H=3.15 | R=0.039 | V=0.39 in



To use with:
TOP.SP.134.24.10

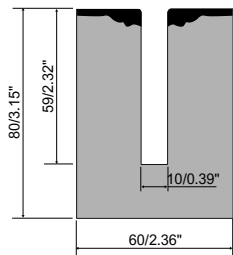

TOP.SM-134.24.12

525 mm 20.67" 16.8 kg
495 mm 19.49" 15.9 kg FC

42Cr:900-1150 N/mm²
500 - 1000 kN/m max.

H=80 | R=1 | V=12 mm
H=3.15 | R=0.039 | V=0.47 in



To use with:
TOP.SP.134.24.12

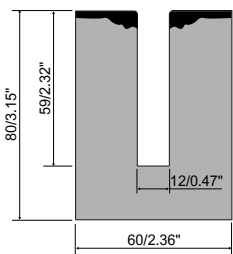

FC: 495 mm - 19.48"
mm: 25-30-35-40-45-50-100-170
in: 0.98-1.18-1.37-1.57-1.77-1.97-3.94-9.84



Create your account on www.rolleritools.com
You can use Rolleri website to check the delivery time, request quotes, stay update with the news, check prices and place orders directly.

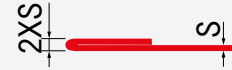

S mm	S in	A mm	A in	R.420 N/mm ² kN/m	R.700 N/mm ² kN/m
0.6	0.02	3.0	0.12	90	150
0.8	0.03	3.0	0.12	120	200
1.0	0.04	3.5	0.14	150	250
1.25	0.05	3.5	0.14	170	260
1.5	0.06	4.6	0.18	220	380
2.0	0.08	5.5	0.22	300	500
2.5	0.10	6.5	0.26	550	-
3.0	0.12	8.0	0.31	700	-

S mm	S in	A mm	A in	R.420 N/mm ² kN/m	R.700 N/mm ² kN/m
0.6	0.02	3.0	0.12	230	350
0.8	0.03	3.0	0.12	320	500
1.0	0.04	3.5	0.14	400	600
1.25	0.05	3.5	0.14	500	800
1.5	0.06	4.6	0.18	630	950
2.0	0.08	5.5	0.22	800	1300
2.5	0.10	6.5	0.26	900	-
3.0	0.12	8.0	0.31	1000	-

S101.35.06

835 mm 32.87" 30 kg
415 mm 16.34" 15.4 kg

35° >

C45: 560-710 N/mm²
600 kN/m max.

35°
H=101 | R=1 | V=6 mm
H=3.98 | R=0.039 | V=0.24 in

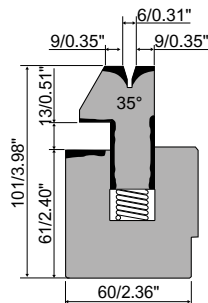

S101.35.08

835 mm 32.87" 30 kg
415 mm 16.34" 15 kg

C45: 560-710 N/mm²
600 kN/m max.

35°
H=101 | R=1 | V=8 mm
H=3.98 | R=0.039 | V=0.31 in

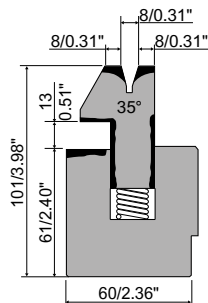

S101.35.10

835 mm 32.87" 30 kg
415 mm 16.34" 15.5 kg

C45: 560-710 N/mm²
600 kN/m max.

35°
H=101 | R=1 | V=10 mm
H=3.98 | R=0.039 | V=0.39 in

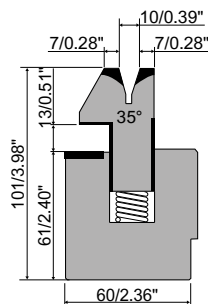

Rolleri hemming dies can also be used as standard dies.

You only have to secure the screws when the die is closed to prevent springs from moving the mobile part upwards.



Request our clamping, punching and ironworker, consumables laser, panel bending tools and shear blades catalogues on www.rolleritools.com/download

S110.30.08

835 mm 32.87" 30 kg
415 mm 16.34" 15 kg

30° >



C45: 560-710 N/mm²
800 kN/m max.

30°

H=110 | R=1.5 | V=8 mm
H=4.33 | R=0.059 | V=0.31 in

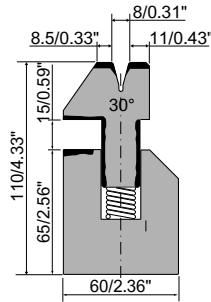

S135.26.08

835 mm 32.87" 39.8 kg
415 mm 16.34" 21 kg

26° >



42Cr:900-1150 N/mm²
400 kN/m max.

26°

H=135 | R=1.5 | V=8 mm
H=5.31 | R=0.059 | V=0.31 in

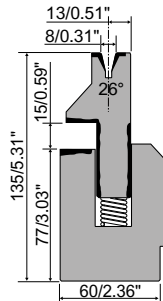

S135.26.10

835 mm 32.87" 41.5 kg
415 mm 16.34" 20.7 kg



C45: 560-710 N/mm²
1000 kN/m max.

26°

H=135 | R=1.5 | V=10 mm
H=5.31 | R=0.059 | V=0.39 in

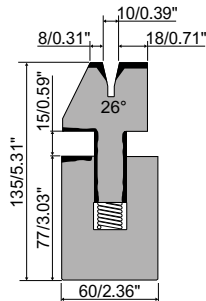

SA135.26.12

835 mm 32.87" 41 kg
415 mm 16.34" 20.5 kg



C45: 560-710 N/mm²
1000 kN/m max.

26°

H=135 | R=2 | V=10 mm
H=5.31 | R=0.079 | V=0.39 in

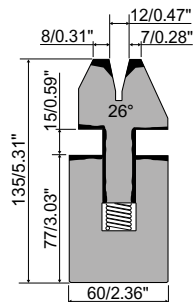

Create your account on www.rolleritools.com
You can use Rolleri website to check the delivery time, request quotes, stay update with the news, check prices and place orders directly.



Download Rolleri Bending App

You will have access to our online store where you can get what you need. You will also get our sheet metal unfolding software for free and our bending rule.



S mm	S in	A mm	A in	R.420 N/mm ² kN/m	R.700 N/mm ² kN/m
0.6	0.02	3.0	0.12	90	150
0.8	0.03	3.0	0.12	120	200
1.0	0.04	3.5	0.14	150	250
1.25	0.05	3.5	0.14	170	260
1.5	0.06	4.6	0.18	220	380
2.0	0.08	5.5	0.22	300	500
2.5	0.10	6.5	0.26	550	-
3.0	0.12	8.0	0.31	700	-

S mm	S in	A mm	A in	R.420 N/mm ² kN/m	R.700 N/mm ² kN/m
0.6	0.02	3.0	0.12	230	350
0.8	0.03	3.0	0.12	320	500
1.0	0.04	3.5	0.14	400	600
1.25	0.05	3.5	0.14	500	800
1.5	0.06	4.6	0.18	630	950
2.0	0.08	5.5	0.22	800	1300
2.5	0.10	6.5	0.26	900	-
3.0	0.12	8.0	0.31	1000	-

S101PN.35.06

835 mm 32.87" 30 kg
415 mm 16.34" 15.5 kg

35° >



C45: 560-710 N/mm²
600 kN/m max.

35°
H=101 | R=1 | V=6 mm
H=3.98 | R=0.039 | V=0.24 in

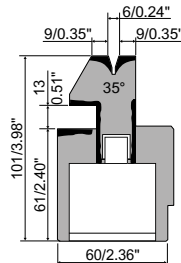

S101PN.35.08

835 mm 32.87" 31 kg
415 mm 16.34" 15.5 kg



C45: 560-710 N/mm²
600 kN/m max.

35°
H=101 | R=1 | V=8 mm
H=3.98 | R=0.039 | V=0.31 in

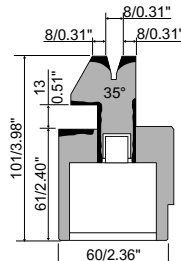

S101PN.35.10

835 mm 32.87" 29.0 kg
415 mm 16.34" 15.5 kg



C45: 560-710 N/mm²
600 kN/m max.

35°
H=101 | R=1 | V=10 mm
H=3.98 | R=0.039 | V=0.39 in

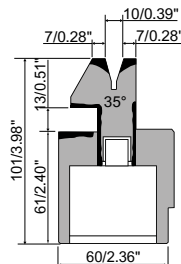

Create your account on www.rolleritools.com
You can use Rolleri website to check the delivery time, request quotes, stay update with the news, check prices and place orders directly.



KPN

1 kg





S110PN.30.08

835 mm 32.87" 30 kg
415 mm 16.34" 15 kg

30° >



C45: 560-710 N/mm²
800 kN/m max.

30°
H=110 | R=1.5 | V=8 mm
H=4.33 | R=0.059 | V=0.31 in

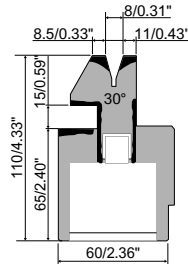

S135PN.26.08

835 mm 32.87" 39.8 kg
415 mm 16.34" 21.2 kg

26° >



42Cr:900-1150 N/mm²
400 kN/m max.

26°
H=135 | R=1.5 | V=8 mm
H=5.31 | R=0.059 | V=0.31 in

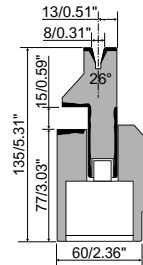

S135PN.26.10

835 mm 32.87" 41.5 kg
415 mm 16.34" 20.7 kg



C45: 560-710 N/mm²
1000 kN/m max.

26°
H=135 | R=1.5 | V=10 mm
H=5.31 | R=0.059 | V=0.39 in

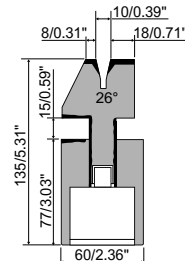

SA135PN.26.12

835 mm 32.87" 41.5 kg
415 mm 16.34" 20.5 kg



C45: 560-710 N/mm²
1000 kN/m max.

26°
H=135 | R=2 | V=12 mm
H=5.31 | R=0.079 | V=0.47 in

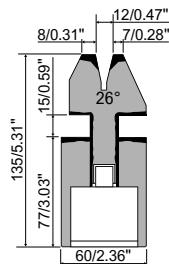

KPN kit for pneumatic hemming dies is a device which opens and closes the hemming die automatically. KPN contains an electrovalve which receives the impulse directly by the press brake CNC and, according to the impulse, it opens and closes air supply to the system. Such feature is very important as it enables operators to improve the

bending sequence safely and time-saving.



S mm	S in	A mm	A in	R.420 N/mm ² kN/m	R.700 N/mm ² kN/m
0.6	0.02	3.0	0.12	90	150
0.8	0.03	3.0	0.12	120	200
1.0	0.04	3.5	0.14	150	250
1.25	0.05	3.5	0.14	170	260
1.5	0.06	4.6	0.18	220	380
2.0	0.08	5.5	0.22	300	500
2.5	0.10	6.5	0.26	550	-
3.0	0.12	8.0	0.31	700	-



S mm	S in	A mm	A in	R.420 N/mm ² kN/m	R.700 N/mm ² kN/m
0.6	0.02	3.0	0.12	230	350
0.8	0.03	3.0	0.12	320	500
1.0	0.04	3.5	0.14	400	600
1.25	0.05	3.5	0.14	500	800
1.5	0.06	4.6	0.18	630	950
2.0	0.08	5.5	0.22	800	1300
2.5	0.10	6.5	0.26	900	-
3.0	0.12	8.0	0.31	1000	-

The new system TOP.SC.130 and TOP.SC.130PN has been designed to flatten sheet metal thicker than 2mm, depending on press brake force.

Dies SM55.12.30 and SM55.14.30 can be used with this new system, as they are made of 42CrMo4, have a wider body and can bear up to 1000kN/m. Flattening with close counterbends has never been so easy.

Dies are interchangeable and have R2 13mm tang.

All standard dies can be mounted with TOP.SC.130. They are fixed by screws positioned on the operator's side.

A very important feature is hemming die opening: being 18mm, pre-bent sheet metal can be easily positioned and flattened without any risk to be slided out.

Standard length is 500mm and hemming dies are available in 2 versions: manual with springs or pneumatic and press brake CNC driven.

The ideal punch to be used with this system is TOP150.30.R12.

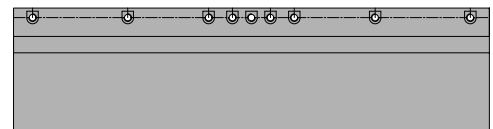
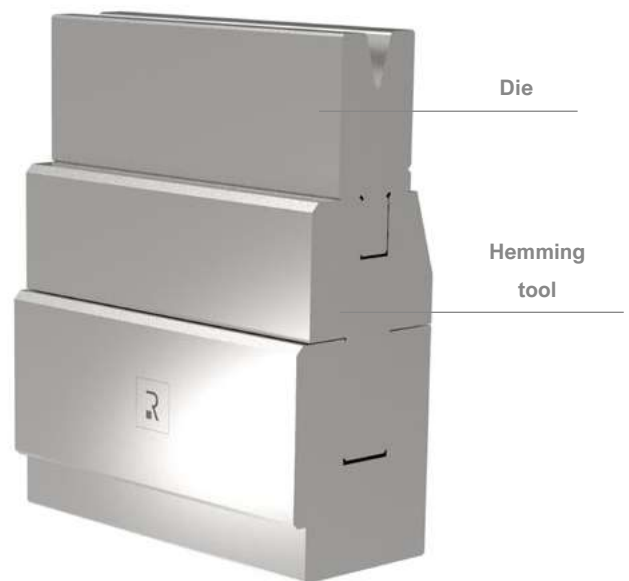

TOP.SC.130

500 mm 19.68" 8.0 kg

42Cr:900-1150 N/mm²
1000 kN/m max.

H=130 mm
H=5.12 in

Spring-loaded hemming dies

NEW



To use with:
TOP150.30.R12

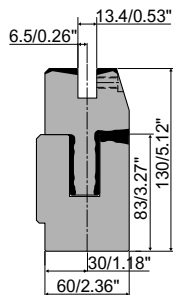

TOP.SC.130PN

500 mm 19.68" 30 kg

42Cr:900-1150 N/mm²
1000 kN/m max.

H=130 mm
H=5.12 in

Pneumatic hemming dies

NEW



Create your account on www.rolleritools.com
You can use Rolleri website to check the delivery time, request quotes, stay update with the news, check prices and place orders directly.



KPN

1 kg





SM55.12.30/C

1000 mm 39.37" 16.0 kg
 500 mm 19.68" 8.0 kg
 1100 mm 43.31" 17.6 kg F

30° >



To use with:
TOP.SC.130
TOP.SC.130PN

42Cr:900-1150 N/mm²
 Bending: 500 kN/m max.
 Hemming: 900 kN/m max.

NEW

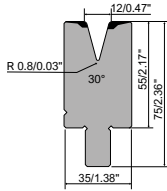

SM55.14.30/C

1000 mm 39.37" 19.0 kg
 500 mm 19.68" 9.5 kg
 1100 mm 43.31" 20.9 kg F



To use with:
TOP.SC.130
TOP.SC.130PN

42Cr:900-1150 N/mm²
 Bending: 600 kN/m max.
 Hemming: 1000 kN/m max.

30°

W=55 | H=75 | R=3.0 | V=14 mm
 W=2.17 | H=2.36 | R=0.12 | V=0.55 in

NEW

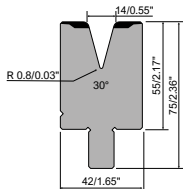

BMR55.06.30/C

500 mm 19.68" 4 kg



To use with:
TOP.SC.130
TOP.SC.130PN

BMR55.08.30/C

500 mm 19.68" 4 kg



42Cr: 900-1150 N/mm²
 200 kN/m max.

30°

W=55 | H=75 | R=0.6 | V=6 mm
 W=2.17 | H=2.36 | R=0.024 | V=0.24 in

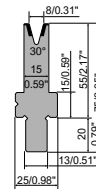
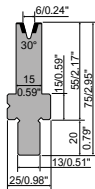

30°
 W=55 | H=75 | R=0.8 | V=8 mm
 W=2.17 | H=2.36 | R=0.031 | V=0.31 in

BMR55.10.30/C

500 mm 19.68" 5 kg



To use with:
TOP.SC.130
TOP.SC.130PN

42Cr: 900-1150 N/mm²
 350 kN/m max.

30°

W=55 | H=75 | R=1.0 | V=10 mm
 W=2.17 | H=2.36 | R=0.039 | V=0.39 in

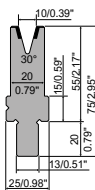

KPN kit for pneumatic hemming dies is a device which opens and closes the hemming die automatically. KPN contains an electrovalve which receives the impulse directly by the press brake CNC and, according to the impulse, it opens and closes air supply to the system. Such feature is very important as it enables operators to improve the bending sequence safely and time-saving.

F: 1100 mm - 43.31"
 mm: 400-200-100-100-75-60-50-40-30-20-15-10
 in: 15.75-7.87-3.94-3.94-2.95-2.36-1.97-1.57-1.18-0.78-0.59-0.39



12100

835 mm 32.87" 8.4 kg
415 mm 16.34" 4.2 kg

90° >



C45: 560-710 N/mm²
600 kN/m max.

90°
H=26 | R=0.4 | V=4 mm
H=26 | R=0.4 | V=7 mm
H=1.02 | R=0.016 | V=0.16 in
H=1.02 | R=0.016 | V=0.28 in

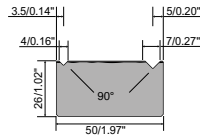

12300

835 mm 32.87" 8.0 kg
415 mm 16.34" 3.9 kg



C45: 560-710 N/mm²
700 kN/m max.

90°
H=26 | R=0.4 | V=6 mm
H=26 | R=0.6 | V=10 mm
H=1.02 | R=0.016 | V=0.24 in
H=1.02 | R=0.024 | V=0.39 in

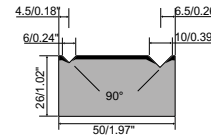

12400

835 mm 32.87" 8.0 kg
415 mm 16.34" 3.9 kg



C45: 560-710 N/mm²
800 kN/m max.

90°
H=26 | R=0.5 | V=8 mm
H=26 | R=0.8 | V=12 mm
H=1.02 | R=0.020 | V=0.31 in
H=1.02 | R=0.031 | V=0.47 in

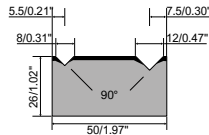

31100

835 mm 32.87" 9.1 kg
415 mm 16.34" 4.5 kg



C45: 560-710 N/mm²
800 kN/m max.

90°
H=26 | R=1.5 | V=6 mm
H=26 | R=2.5 | V=10 mm
H=1.02 | R=0.06 | V=0.24 in
H=1.02 | R=0.098 | V=0.39 in

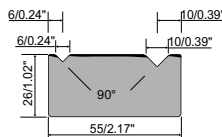

12106

835 mm 32.87" 8.4 kg
415 mm 16.34" 4.2 kg

88° >



C45: 560-710 N/mm²
600 kN/m max.

88°
H=25.5 | R=0.4 | V=4 mm
H=25.5 | R=0.4 | V=7 mm
H=1.00 | R=0.016 | V=0.16 in
H=1.00 | R=0.016 | V=0.28 in

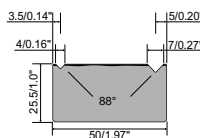

12306

835 mm 32.87" 8.0 kg
415 mm 16.34" 3.9 kg



C45: 560-710 N/mm²
700 kN/m max.

88°
H=25.5 | R=0.4 | V=6 mm
H=25.5 | R=0.6 | V=10 mm
H=1.00 | R=0.016 | V=0.24 in
H=1.00 | R=0.024 | V=0.39 in

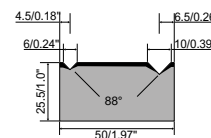

R1A series dies have the same standard dimensions of Amada style dies. V opening and radii match exactly the parameters set in press brake CNC, so working programs don't need any change or correction.



Download Roller Bending App

You will have access to our online store where you can get what you need. You will also get our sheet metal unfolding software for free and our bending rule.



12406

835 mm 32.87" 8.4 kg
415 mm 16.34" 7.8 kg



C45: 560-710 N/mm²
800 kN/m max.

88°

H=25.5 | R=0.5 | V=8 mm
H=25.5 | R=0.8 | V=12 mm
H=1.00 | R=0.020 | V=0.31 in
H=1.00 | R=0.031 | V=0.47 in

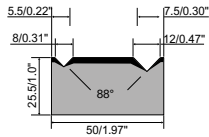

12500

835 mm 32.87" 7.7 kg
415 mm 16.34" 3.8.0 kg



C45: 560-710 N/mm²
1000 kN/m max.

88°

H=26 | R=0.5 | V=14 mm
H=26 | R=0.5 | V=18 mm
H=1.02 | R=0.020 | V=0.55 in
H=1.02 | R=0.020 | V=0.71 in

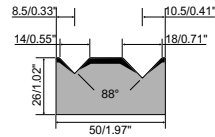

12600

835 mm 32.87" 7.5 kg
415 mm 16.34" 3.7 kg



C45: 560-710 N/mm²
1000 kN/m max.

88°

H=26 | R=0.5 | V=12 mm
H=26 | R=0.5 | V=20 mm
H=1.02 | R=0.020 | V=0.47 in
H=1.02 | R=0.020 | V=0.79 in

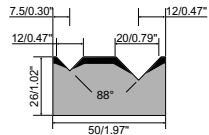

12700

835 mm 32.87" 7 kg
415 mm 16.34" 3.4.0 kg



C45: 560-710 N/mm²
700 kN/m max.

88°

H=26 | R=0.8 | V=16 mm
H=26 | R=0.8 | V=25 mm
H=1.02 | R=0.031 | V=0.63 in
H=1.02 | R=0.031 | V=0.98 in

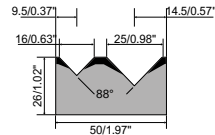

31106

835 mm 32.87" 8.9 kg
415 mm 16.34" 4.4.0 kg



C45: 560-710 N/mm²
800 kN/m max.

88°

H=25.5 | R=1.5 | V=6 mm
H=25.5 | R=2.5 | V=10 mm
H=1.00 | R=0.06 | V=0.24 in
H=1.00 | R=0.098 | V=0.39 in

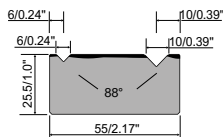

31400

835 mm 32.87" 7.5 kg
415 mm 16.34" 3.7 kg



C45: 560-710 N/mm²
1000 kN/m max.

88°

H=26 | R=3 | V=12 mm
H=26 | R=4 | V=20 mm
H=1.02 | R=0.118 | V=0.47 in
H=1.02 | R=0.157 | V=0.79 in

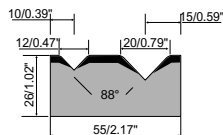

Create your account on www.rolleritools.com
You can use Rolleri website to check the delivery time, request quotes, stay update with the news, check prices and place orders directly.



The Bending handbook target is to supply practice and useful information to reach quickly the required result. A lot of examples, easy formulas and information which explain the proper attitude towards the bending process.

30148

835 mm	32.87"	14.2 kg	
415 mm	16.34"	7.1 kg	
795 mm	31.29"	13.5 kg	FX
835 mm	32.87"	13.7 kg	FC

90° >



C45: 560-710 N/mm²
600 kN/m max.

90°
H=46 | R=0.4 | V=4 mm
H=46 | R=0.4 | V=7 mm
H=1.81 | R=0.016 | V=0.16 in
H=1.81 | R=0.016 | V=0.28 in

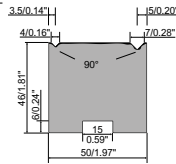

30248

835 mm	32.87"	14.2 kg	
415 mm	16.34"	7.1 kg	
795 mm	31.29"	13.5 kg	FX
835 mm	32.87"	13.7 kg	FC

C45: 560-710 N/mm²
700 kN/m max.

90°
H=46 | R=0.4 | V=6 mm
H=46 | R=0.6 | V=10 mm
H=1.81 | R=0.016 | V=0.24 in
H=1.81 | R=0.023 | V=0.39 in

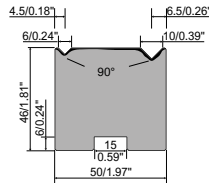

30348

835 mm	32.87"	14.2 kg	
415 mm	16.34"	7.1 kg	
795 mm	31.29"	13.5 kg	FX
835 mm	32.87"	13.7 kg	FC

C45: 560-710 N/mm²
700 kN/m max.

90°
H=46 | R=0.5 | V=8 mm
H=46 | R=0.8 | V=12 mm
H=1.81 | R=0.016 | V=0.31 in
H=1.81 | R=0.016 | V=0.47 in

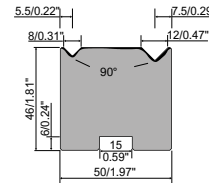

50190

835 mm	32.87"	9.7 kg	
415 mm	16.34"	4.8 kg	
795 mm	31.29"	9.2 kg	FX
835 mm	32.87"	9.4 kg	FC

Self centering



C45: 560-710 N/mm²
600 kN/m max.

90°
H=46 | R=0.4 | V=4 mm
H=46 | R=0.4 | V=7 mm
H=1.81 | R=0.016 | V=0.16 in
H=1.81 | R=0.016 | V=0.28 in

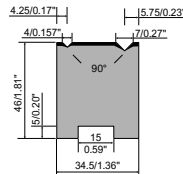

50790

835 mm	32.87"	10.0 kg	
415 mm	16.34"	5.0 kg	
795 mm	31.29"	9.5 kg	FX
835 mm	32.87"	9.7 kg	FC

Self centering



C45: 560-710 N/mm²
600 kN/m max.

90°
H=46 | R=0.4 | V=5 mm
H=46 | R=0.6 | V=9 mm
H=1.81 | R=0.016 | V=0.196 in
H=1.81 | R=0.023 | V=0.35 in

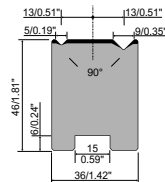

FX: 795 mm - 31.29"

mm: 100-250-20-25-30-35-40-45-50-200
in: 3.94-9.84-0.78-0.98-1.18-1.37-1.57-1.77-1.96-7.87

FC: 835 mm - 32.87"

mm: 10-15-20-40-50-100-200-400
in: 0.39-0.59-0.78-1.57-1.96-3.94 -7.87-15.75





50290

835 mm 32.87" 10.3 kg
 415 mm 16.34" 5.2 kg
 795 mm 31.29" 10.0 kg FX
 835 mm 32.87" 10.1 kg FC

Self centering



C45: 560-710 N/mm²
 700 kN/m max.

90°

H=46 | R=0.4 | V=6 mm
 H=46 | R=0.6 | V=10 mm
 H=1.81 | R=0.016 | V=0.24 in
 H=1.81 | R=0.024 | V=0.39 in

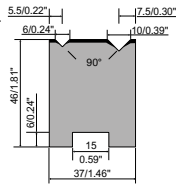

50390

835 mm 32.87" 10.7 kg
 415 mm 16.34" 5.3 kg
 795 mm 31.29" 10.7 kg FX
 835 mm 32.87" 10.7 kg FC

Self centering



C45: 560-710 N/mm²
 700 kN/m max.

90°

H=46 | R=0.5 | V=8 mm
 H=46 | R=0.8 | V=12 mm
 H=1.81 | R=0.019 | V=0.31 in
 H=1.81 | R=0.031 | V=0.47 in

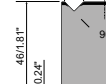
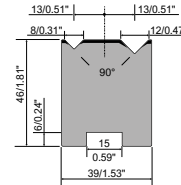

30147

835 mm 32.87" 14.2 kg
 415 mm 16.34" 7.1 kg
 795 mm 31.29" 13.5 kg FX
 835 mm 32.87" 13.7 kg FC

88° >



C45: 560-710 N/mm²
 600 kN/m max.

88°

H=45.5 | R=0.4 | V=4 mm
 H=45.5 | R=0.4 | V=7 mm
 H=1.79 | R=0.016 | V=0.16 in
 H=1.79 | R=0.016 | V=0.27 in

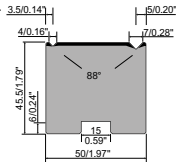

30247

835 mm 32.87" 14.0 kg
 415 mm 16.34" 8.4 kg
 795 mm 31.29" 16.2 kg FX
 835 mm 32.87" 16.4 kg FC

C45: 560-710 N/mm²
 700 kN/m max.

88°

H=45.5 | R=0.4 | V=6 mm
 H=45.5 | R=0.6 | V=10 mm
 H=1.79 | R=0.016 | V=0.24 in
 H=1.79 | R=0.024 | V=0.39 in

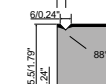
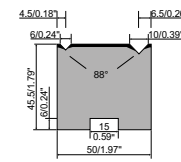

30347

835 mm 32.87" 14.2 kg
 415 mm 16.34" 7.1 kg
 795 mm 31.29" 13.5 kg FX
 835 mm 32.87" 13.7 kg FC



C45: 560-710 N/mm²
 700 kN/m max.

88°

H=45.5 | R=0.5 | V=8 mm
 H=45.5 | R=0.8 | V=12 mm
 H=1.79 | R=0.019 | V=0.31 in
 H=1.79 | R=0.031 | V=0.47 in

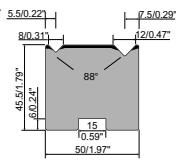

30448

835 mm 32.87" 13.5 kg
 415 mm 16.34" 6.7 kg
 795 mm 31.29" 13.5 kg FX
 835 mm 32.87" 13.7 kg FC



C45: 560-710 N/mm²
 1000 kN/m max.

88°

H=46 | R=0.5 | V=14 mm
 H=46 | R=0.5 | V=18 mm
 H=1.81 | R=0.019 | V=0.55 in
 H=1.81 | R=0.019 | V=0.71 in

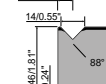
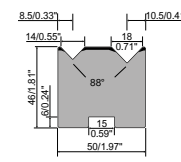

30548

835 mm 32.87" 13.5 kg
 415 mm 16.34" 6.7 kg
 795 mm 31.29" 13.5 kg FX
 835 mm 32.87" 13.7 kg FC



C45: 560-710 N/mm²
 1000 kN/m max.

88°

H=46 | R=0.5 | V=12 mm
 H=46 | R=0.5 | V=20 mm
 H=1.81 | R=0.019 | V=0.47 in
 H=1.81 | R=0.019 | V=0.79 in

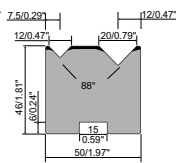

30648

835 mm 32.87" 12.9 kg
 415 mm 16.34" 6.4 kg
 795 mm 31.29" 13.5 kg FX
 835 mm 32.87" 13.7 kg FC



C45: 560-710 N/mm²
 1000 kN/m max.

88°

H=46 | R=0.8 | V=16 mm
 H=46 | R=0.8 | V=25 mm
 H=1.81 | R=0.031 | V=0.63 in
 H=1.81 | R=0.031 | V=0.98 in

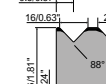
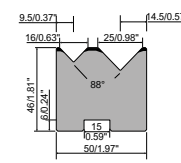

FX: 795 mm - 31.29"

mm: 100-250-20-25-30-35-40-45-50-200

in: 3.94-9.84-0.78-0.98-1.18-1.37-1.57-1.77-1.96-7.87

FC: 835 mm - 32.87"

mm: 10-15-20-40-50-100-200-400

in: 0.39-0.59-0.78-1.57-1.96-3.94 -7.87-15.75





50196

835 mm 32.87" 9.5.0 kg
 415 mm 16.34" 4.8.0 kg
 795 mm 31.29" 9.5.0 kg FX
 835 mm 32.87" 9.5.0 kg FC

Self centering



C45: 560-710 N/mm²
 600 kN/m max.

88°
 H=45.5 | R=0.4 | V=4 mm
 H=45.5 | R=0.4 | V=7 mm
 H=1.79 | R=0.016 | V=0.16 in
 H=1.79 | R=0.016 | V=0.28 in

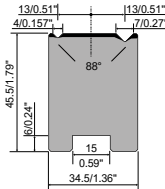

50296

835 mm 32.87" 10.4 kg
 415 mm 16.34" 5.2 kg
 795 mm 31.29" 10.4 kg FX
 835 mm 32.87" 10.4 kg FC

Self centering



C45: 560-710 N/mm²
 700 kN/m max.

88°
 H=45.5 | R=0.4 | V=6 mm
 H=45.5 | R=0.6 | V=10 mm
 H=1.76 | R=0.016 | V=0.24 in
 H=1.76 | R=0.023 | V=0.39 in

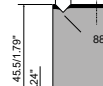
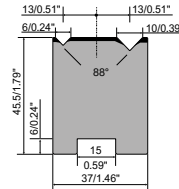

50796

835 mm 32.87" 10.0 kg
 415 mm 16.34" 5.0 kg
 795 mm 31.29" 9.5.0 kg FX
 835 mm 32.87" 9.5.0 kg FC

Self centering



C45: 560-710 N/mm²
 600 kN/m max.

88°
 H=45.5 | R=0.4 | V=5 mm
 H=45.5 | R=0.6 | V=9 mm
 H=1.79 | R=0.016 | V=0.2 in
 H=1.79 | R=0.024 | V=0.35 in

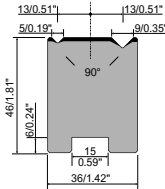

50396

835 mm 32.87" 10.8 kg
 415 mm 16.34" 5.3 kg
 795 mm 31.29" 10.8 kg FX
 835 mm 32.87" 10.8 kg FC

Self centering



C45: 560-710 N/mm²
 700 kN/m max.

88°
 H=45.5 | R=0.5 | V=8 mm
 H=45.5 | R=0.8 | V=12 mm
 H=1.79 | R=0.019 | V=0.31 in
 H=1.79 | R=0.019 | V=0.47 in

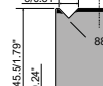
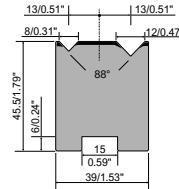

50490

835 mm 32.87" 12 kg
 415 mm 16.34" 5.3 kg
 795 mm 31.29" 10.8 kg FX
 835 mm 32.87" 10.8 kg FC

Self centering



C45: 560-710 N/mm²
 1000 kN/m max.

88°
 H=46 | R=0.5 | V=14 mm
 H=46 | R=0.5 | V=18 mm
 H=1.81 | R=0.019 | V=0.55 in
 H=1.81 | R=0.019 | V=0.71 in

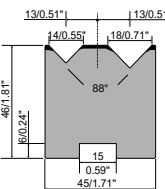

50590

835 mm 32.87" 12.2 kg
 415 mm 16.34" 6.1 kg
 795 mm 31.29" 12.2 kg FX
 835 mm 32.87" 12.2 kg FC

Self centering



C45: 560-710 N/mm²
 700 kN/m max.

88°
 H=46 | R=0.5 | V=12 mm
 H=46 | R=0.5 | V=20 mm
 H=1.81 | R=0.019 | V=0.47 in
 H=1.81 | R=0.019 | V=0.78 in

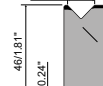
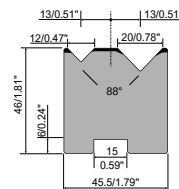

50690

835 mm 32.87" 13 kg
 415 mm 16.34" 6.5 kg
 795 mm 31.29" 12.4 kg FX
 835 mm 32.87" 12.6 kg FC

Self centering



C45: 560-710 N/mm²
 1000 kN/m max.

88°
 H=46 | R=0.8 | V=16 mm
 H=46 | R=0.8 | V=25 mm
 H=1.81 | R=0.031 | V=0.63 in
 H=1.81 | R=0.031 | V=0.98 in

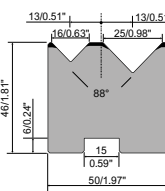

FX: 795 mm - 31.29"

mm: 100-250-20-25-30-35-40-45-50 -200

in: 3.94-9.84-0.78-0.98-1.18-1.37-1.57-1.77-1.96-7.87

FC: 835 mm - 32.87"

mm: 10-15-20-40-50-100-200-400

in: 0.39-0.59-0.78-1.57-1.96-3.94 -7.87-15.75



30000

835 mm 32.87" 3.7 kg
415 mm 16.34" 1.9.0 kg



C45: 560-710 N/mm²
1000 kN/m max.

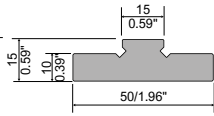

Example of application



33700

835 mm 32.87" 13.3 kg
415 mm 16.34" 5.6 kg



42Cr:900-1500 N/mm²
300 kN/m max.

90°
R=1 | V=8 mm
R=1 | V=12 mm
R=0.039 | V=0.31 in
R=0.039 | V=0.47 in

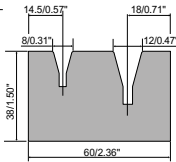

Request our clamping, punching and ironworker, consumables laser, panel bending tools and shear blades catalogues on www.rolleritools.com/download



Create your account on www.rolleritools.com
You can use Rolleri website to check the delivery time, request quotes, stay update with the news, check prices and place orders directly.

32000

835 mm 32.87" 3 kg
415 mm 16.34" 1.5.0 kg

C45: 560-710 N/mm²
950 kN/m max.

90°
H=30 | R=1.5 | V=6 mm
H=1.18 | R=0.059 | V=0.24 in

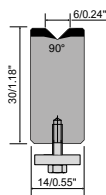

32100

835 mm 32.87" 3 kg
415 mm 16.34" 1.5.0 kg

C45: 560-710 N/mm²
950 kN/m max.

90°
H=30 | R=1.5 | V=8 mm
H=1.18 | R=0.059 | V=0.31 in

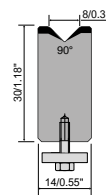

32300

835 mm 32.87" 3 kg
415 mm 16.34" 1.5.0 kg

C45: 560-710 N/mm²
950 kN/m max.

90°
H=60 | R=2 | V=10 mm
H=2.36 | R=0.079 | V=0.39 in

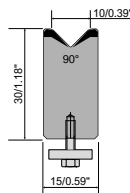

32600

835 mm 32.87" 2.9 kg
415 mm 16.34" 1.5.0 kg

C45: 560-710 N/mm²
1000 kN/m max.

90°
H=30 | R=2.5 | V=12 mm
H=1.18 | R=0.098 | V=0.47 in

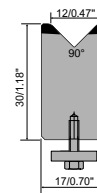

32006

835 mm 32.87" 3 kg
415 mm 16.34" 1.5.0 kg

C45: 560-710 N/mm²
950 kN/m max.

88°
H=29.5 | R=1.5 | V=6 mm
H=1.16 | R=0.059 | V=0.24 in

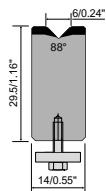

32106

835 mm 32.87" 3 kg
415 mm 16.34" 1.5.0 kg

C45: 560-710 N/mm²
950 kN/m max.

88°
H=29.5 | R=1.5 | V=8 mm
H=2.36 | R=0.059 | V=0.31 in

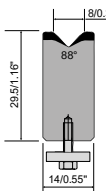

32200

835 mm 32.87" 3 kg
415 mm 16.34" 1.5.0 kg

C45: 560-710 N/mm²
950 kN/m max.

88°
H=30 | R=2 | V=10 mm
H=1.18 | R=0.079 | V=0.39 in

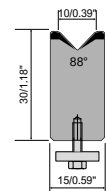

R1A self centering dies are designed to be mounted with 33000 serie holders.

Hole pitch is standard.

Such 1-V dies align the V opening with the punch tip axis autonomously, so the press brake upper beam has to go down without sheet metal

to position the dies properly. Afterwards, the operator can screw the dies to their holder and keep the same alignment.



32400

835 mm 32.87" 3 kg
415 mm 16.34" 1.50 kg

C45: 560-710 N/mm²
1000 kN/m max.

88°

H=30 | R=2.5 | V=12 mm
H=1.18 | R=0.098 | V=0.47

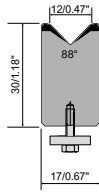

32500

835 mm 32.87" 3.3 kg
415 mm 16.34" 1.6 kg

C45: 560-710 N/mm²
1000 kN/m max.

88°

H=60 | R=2.5 | V=14 mm
H=2.36 | R=0.098 | V=0.55

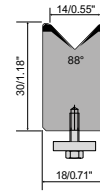

33000

835 mm 32.87" 12.7 kg
415 mm 16.34" 6.3 kg

C45: 560-710 N/mm²
1000 kN/m max.

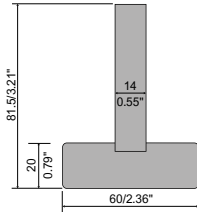

Example of application

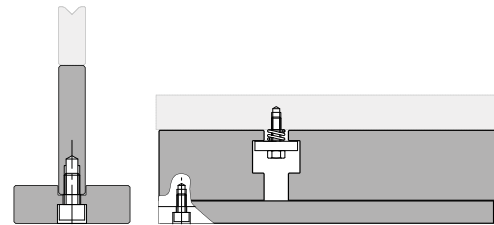

07000

835 mm 32.87" 5.5 kg
415 mm 16.34" 2.7 kg
795 mm 31.29" 5.2 kg FX
835 mm 32.87" 5.3 kg F

C45: 560-710 N/mm²
950 kN/m max.

90°

H=60 | R=1.5 | V=6 mm
H=2.36 | R=0.059 | V=0.24 in

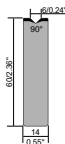

90° >



07100

835 mm 32.87" 5.5 kg
415 mm 16.34" 2.7 kg
795 mm 31.29" 5.2 kg FX
835 mm 32.87" 5.3 kg F

C45: 560-710 N/mm²
950 kN/m max.

90°

H=60 | R=1.5 | V=8 mm
H=2.36 | R=0.059 | V=0.31 in

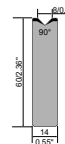

07300

835 mm 32.87" 6 kg
415 mm 16.34" 3 kg
795 mm 31.29" 5.3 kg FX
835 mm 32.87" 5.4 kg F

C45: 560-710 N/mm²
950 kN/m max.

90°

H=60 | R=2 | V=10 mm
H=2.36 | R=0.079 | V=0.39 in

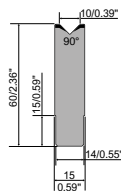

07500

835 mm 32.87" 6.1 kg
415 mm 16.34" 3 kg
795 mm 31.29" 5.8 kg FX
835 mm 32.87" 5.9 kg F

C45: 560-710 N/mm²
950 kN/m max.

90°

H=60 | R=2.5 | V=12 mm
H=2.36 | R=0.098 | V=0.47 in

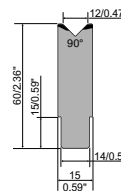

Download Rolleri Bending App

You will have access to our online store where you can get what you need. You will also get our sheet metal unfolding software for free and our bending rule.



Create your account on www.rolleritools.com

You can use Rolleri website to check the delivery time, request quotes, stay update with the news, check prices and place orders directly.

07006

835 mm	32.87"	5.5 kg	
415 mm	16.34"	2.7 kg	
795 mm	31.29"	5.2 kg	FX
835 mm	32.87"	5.3 kg	FC

88° >



C45: 560-710 N/mm²
950 kN/m max.

88°
H=60 | R=1.5 | V=6 mm
H=2.36 | R=0.059 | V=0.24 in

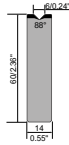

07106

835 mm	32.87"	6 kg	
415 mm	16.34"	3 kg	
795 mm	31.29"	5.4 kg	FX
835 mm	32.87"	5.5 kg	FC



C45: 560-710 N/mm²
950 kN/m max.

88°
H=60 | R=1.5 | V=8 mm
H=2.36 | R=0.059 | V=0.31 in

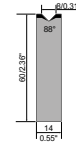

07200

835 mm	32.87"	6 kg	
415 mm	16.34"	3 kg	
795 mm	31.29"	5.4 kg	FX
835 mm	32.87"	5.5 kg	FC



C45: 560-710 N/mm²
950 kN/m max.

88°
H=60 | R=2 | V=10 mm
H=2.36 | R=0.079 | V=0.39 in

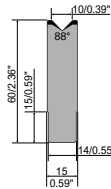

07400

835 mm	32.87"	6 kg	
415 mm	16.34"	3 kg	
795 mm	31.29"	5.8 kg	FX
835 mm	32.87"	5.9 kg	FC



C45: 560-710 N/mm²
950 kN/m max.

88°
H=60 | R=2.5 | V=12 mm
H=2.36 | R=0.098 | V=0.31 in

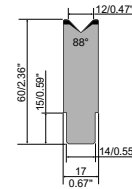

07600

835 mm	32.87"	6.1 kg	
415 mm	16.34"	3 kg	
795 mm	31.29"	5.8 kg	FX
835 mm	32.87"	5.9 kg	FC



C45: 560-710 N/mm²
950 kN/m max.

88°
H=60 | R=2.5 | V=14 mm
H=2.36 | R=0.098 | V=0.55 in

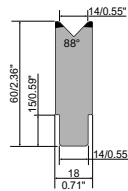

FX: 795 mm - 31.29"

mm: 100-250-20-25-30-35-40-45-50 -200

in: 3.94-9.84-0.78-0.98-1.18-1.37-1.57-1.77-1.96-7.87

FC: 835 mm - 32.87"

mm: 10-15-20-40-50-100-200-400

in: 0.39-0.59-0.78-1.57-1.96-3.94 -7.87-15.75



03500



835 mm 32.87" 21.7 kg
 415 mm 16.34" 10.8 kg
 795 mm 31.29" 21.7 kg FX
 805 mm 31.69" 21.7 kg F

C45: 560-710 N/mm²
 1000 kN/m max.

85°
 H=60 | R=4 | V=32 mm
 H=2.36 | R=0.157 | V=1.26 in

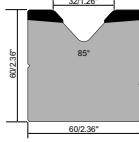

03600



835 mm 32.87" 20.5 kg
 415 mm 16.34" 10.2 kg
 795 mm 31.29" 19.5 kg FX
 805 mm 31.69" 19.7 kg F

C45: 560-710 N/mm²
 1000 kN/m max.

85°
 H=60 | R=4 | V=40 mm
 H=2.36 | R=0.157 | V=1.57 in

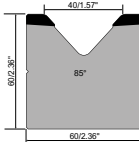

03700



835 mm 32.87" 18.9 kg
 415 mm 16.34" 9.4.0 kg
 795 mm 31.29" 18.9 kg FX
 805 mm 31.69" 18.9 kg F

C45: 560-710 N/mm²
 1000 kN/m max.

85°
 H=60 | R=4 | V=50 mm
 H=2.36 | R=0.157 | V=1.97 in

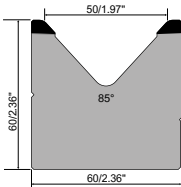

03800



835 mm 32.87" 29.2 kg
 415 mm 16.34" 14.5 kg
 795 mm 31.29" 29.2 kg FX
 805 mm 31.69" 29.2 kg F

C45: 560-710 N/mm²
 1000 kN/m max.

85°
 H=75 | R=5 | V=63 mm
 H=2.95 | R=0.196 | V=2.48 in

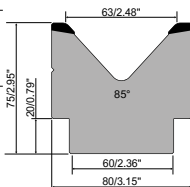

FX: 795 mm - 31.29"

mm: 100-250-20-25-30-35-40-45-50 -200

in: 3.94-9.84-0.78-0.98-1.18-1.37-1.57-1.77-1.96-7.87

F: 805 mm - 31.69"

mm: 200-50-40-20-15-10-370-100

in: 7.87-1.97-1.57-0.78-0.59-0.39-14.56-3.94



01360

835 mm	32.87"	42.6 kg	
415 mm	16.34"	21.2 kg	
795 mm	31.29"	42.6 kg	FX
805 mm	31.69"	42.6 kg	F

85° >



C45: 560-710 N/mm²
700 kN/m max.

85°
H=95 | R=6 | V=80 mm
H=3.74 | R=0.236 | V=3.15 in

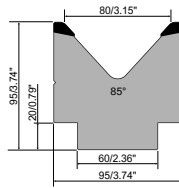

34200

835 mm	32.87"	19.2 kg	
415 mm	16.34"	9.6 kg	
795 mm	31.29"	19.2 kg	FX
805 mm	31.69"	19.2 kg	F

45° >



C45: 560-710 N/mm²
400 kN/m max.

45°
H=60 | R=5 | V=32 mm
H=2.36 | R=0.196 | V=1.26 in

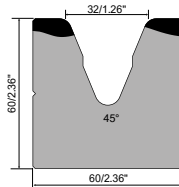

34300

835 mm	32.87"	32.7 kg	
415 mm	16.34"	16.2 kg	
795 mm	31.29"	31.1 kg	FX
805 mm	31.69"	31.5 kg	F

45° >



C45: 560-710 N/mm²
700 kN/m max.

45°
H=80 | R=5 | V=40 mm
H=3.15 | R=0.196 | V=1.57 in

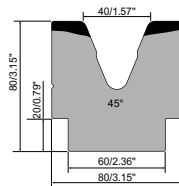

34000

835 mm	32.87"	21.5 kg	
415 mm	16.34"	10.7 kg	
795 mm	31.29"	21.5 kg	FX
805 mm	31.69"	21.5 kg	F

30° >



C45: 560-710 N/mm²
800 kN/m max.

30°
H=60 | R=3 | V=18 mm
H=2.36 | R=0.118 | V=0.71 in

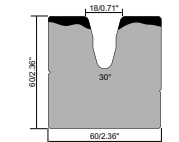

FX: 795 mm - 31.29"

mm: 100-250-20-25-30-35-40-45-50 -200

in: 3.94-9.84-0.78-0.98-1.18-1.37-1.57-1.77-1.96-7.87

F: 805 mm - 31.69"

mm: 200-50-40-20-15-10-370-100

In: 7.87-1.97-1.57-0.78-0.59-0.39-14.56-3.94



34100



835 mm 32.87" 21.7 kg
 415 mm 16.34" 10.8 kg
 795 mm 31.29" 21.7 kg FX
 805 mm 31.69" 21.7 kg F

C45: 560-710 N/mm²
 600 kN/m max.

30°

H=65 | R=4 | V=25 mm

H=2.56 | R=0.157 | V=0.98 in

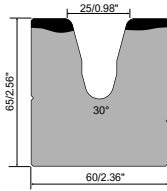

05500



835 mm 32.87" 21.7 kg
 415 mm 16.34" 10.8 kg

C45: 560-710 N/mm²
 1000 kN/m max.

Holder

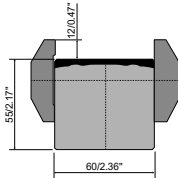

FX: 795 mm - 31.29"

mm: 100-250-20-25-30-35-40-45-50 -200

in: 3.94-9.84-0.78-0.98-1.18-1.37-1.57-1.77-1.96-7.87



F: 805 mm - 31.69"

mm: 200-50-40-20-15-10-370-100

in: 7.87-1.97-1.57-0.78-0.59-0.39-14.56-3.94



CFH dies are designed to complete the range of CFH tools and guarantee the same dimensions of Amada style tools.

Rolleri CFH dies range from 86° to 30°, are 835mm 32.87", 510mm 20.08", 415mm 16.34", 200mm 7.87" long and have 805mm, 795mm and 370mm sectioned sets.

Furthermore, in order to meet all bending requirements, they are made of 42CrMo4 tool steel and undergo a specific heating treatment to reach certain hardness level which can improve the tool operational life.

Available on request:

510 mm | 20.08"

200 mm | 7.87"

370 mm | 14.57"

mm: 100-300-150-50-40-20-15-10-100

in: 3.94-11.81-5.90-1.96-1.57-0.79-0.59-0-0.39-3.94

CFH60.06.86

835 mm 32.87" 5.1 kg
415 mm 16.34" 2.5 kg
800 mm 31.50" 4.8 kg F

86° >



42Cr:900-1500 N/mm²
800 kN/m max.

86°
H=60 | R=1.5 | V=6 mm
H=2.36 | R=0.059 | V=0.23 in

NEW

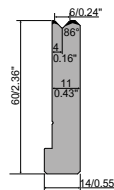

CFH60.08.86

835 mm 32.87" 5.1 kg
415 mm 16.34" 2.5 kg
800 mm 31.50" 4.8 kg F



42Cr:900-1500 N/mm²
900 kN/m max.

86°
H=60 | R=1.5 | V=8 mm
H=2.36 | R=0.059 | V=0.31 in

NEW

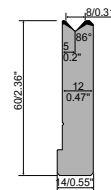

CFH60.10.86

835 mm 32.87" 5.3 kg
415 mm 16.34" 2.6 kg
800 mm 31.50" 5.0 kg F



42Cr:900-1500 N/mm²
1000 kN/m max.

86°
H=60 | R=2 | V=10 mm
H=2.36 | R=0.079 | V=0.39 in

NEW

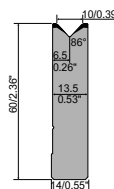

CFH60.12.86

835 mm 32.87" 5.5 kg
415 mm 16.34" 2.7 kg
800 mm 31.50" 5.2 kg F



42Cr:900-1500 N/mm²
650 kN/m max.

86°
H=60 | R=2.5 | V=12 mm
H=2.36 | R=0.098 | V=0.47 in

NEW

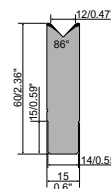

CFH60.14.86

835 mm 32.87" 6.2 kg
415 mm 16.34" 3.0 kg
800 mm 31.50" 5.8 kg F



42Cr:900-1500 N/mm²
1000 kN/m max.

86°
H=60 | R=2.5 | V=14 mm
H=2.36 | R=0.098 | V=0.55 in

NEW

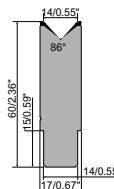

CFH60.16.86

835 mm 32.87" 7.0 kg
415 mm 16.34" 3.4 kg
800 mm 31.50" 6.6 kg F



42Cr:900-1500 N/mm²
1000 kN/m max.

86°
H=60 | R=2.5 | V=16 mm
H=2.36 | R=0.098 | V=0.63 in

NEW

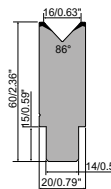

F: 800 mm - 21.49"

mm: 100-10-15-15-20-40-50-150-400

in: 3.94-0.39-0.59-0.59-0.79-1.57-1.97-5.90-15.74



Create your account on www.rolleritools.com
You can use Rolleri website to check the delivery time, request quotes, stay update with the news, check prices and place orders directly.



CFH60.18.86

835 mm 32.87" 7.4 kg
 415 mm 16.34" 3.6 kg
 800 mm 31.50" 7.0 kg F

42Cr:900-1500 N/mm²
 1000 kN/m max.

86°
 H=60 | R=2.5 | V=18 mm
 H=2.36 | R=0.098 | V=0.71 in

NEW

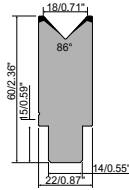

CFH60.20.86

835 mm 32.87" 8.0 kg
 415 mm 16.34" 3.9 kg
 800 mm 31.50" 7.5 kg F

42Cr:900-1500 N/mm²
 1000 kN/m max.

86°
 H=60 | R=3 | V=20 mm
 H=2.36 | R=0.118 | V=0.79 in

NEW

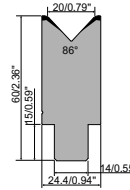

CFH60.25.86

835 mm 32.87" 9.5 kg
 415 mm 16.34" 4.6 kg
 800 mm 31.50" 9.0 kg F

42Cr:900-1500 N/mm²
 1000 kN/m max.

86°
 H=60 | R=3 | V=25 mm
 H=2.36 | R=0.118 | V=0.98 in

NEW

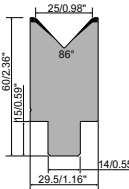

CFH.60.04.30

30° >

835 mm 32.87" 5.8 kg
 415 mm 16.34" 2.9 kg
 800 mm 31.50" 5.6 kg F

42Cr:900-1500 N/mm²
 300 kN/m max.

30°
 H=60 | R=1 | V=4 mm
 H=2.36 | R=0.039 | V=0.16 in

NEW

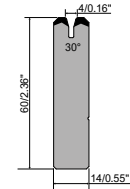

CFH.60.06.30

835 mm 32.87" 6.3 kg
 415 mm 16.34" 3.1 kg
 800 mm 31.50" 6.0 kg F

42Cr:900-1500 N/mm²
 300 kN/m max.

30°
 H=60 | R=1 | V=6 mm
 H=2.36 | R=0.039 | V=0.24 in

NEW

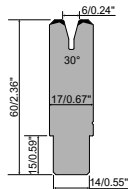

CFH.60.08.30

835 mm 32.87" 6.8 kg
 415 mm 16.34" 3.4 kg
 800 mm 31.50" 6.6 kg F

42Cr:900-1500 N/mm²
 350 kN/m max.

30°
 H=60 | R=1.5 | V=8 mm
 H=3.15 | R=0.059 | V=0.31 in

NEW

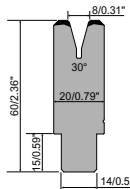

CFH.60.10.30

835 mm 32.87" 8.0 kg
 415 mm 16.34" 3.9 kg
 800 mm 31.50" 7.7 kg F

42Cr:900-1500 N/mm²
 350 kN/m max.

30°
 H=60 | R=2 | V=10 mm
 H=2.36 | R=0.079 | V=0.39 in

NEW

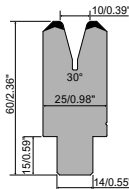

CFH.60.12.30

835 mm 32.87" 9.2 kg
 415 mm 16.34" 4.6 kg
 800 mm 31.50" 8.8 kg F

42Cr:900-1500 N/mm²
 350 kN/m max.

30°
 H=60 | R=2.5 | V=12 mm
 H=3.15 | R=0.098 | V=0.47 in

NEW

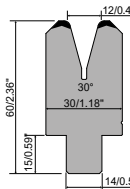

F: 800 mm - 21.49"

mm: 100-10-15-15-20-40-50-150-400

in: 3.94-0.39-0.59-0.59-0.79-1.57-1.97-5.90-15.74



Download Roller Bending App

You will have access to our online store where you can get what you need. You will also get our sheet metal unfolding software for free and our bending rule.

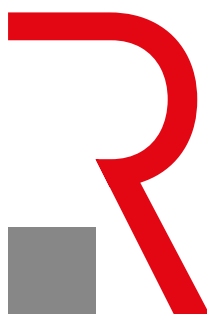

English edition 1.0 | 2020

Rolleri S.p.A.

Via Artigiani · Loc. Cabina · 29020

Vigolzone (PC) · Italy

Tel. +39 0523 870905

Fax +39 0523 879030

www.rolleritools.com

sales@rolleri.it

in

linkedin

f

facebook



instagram



twitter

**You
Tube**

youtube



vimeo